



# ACCESSORIES 2022 SNOWMOBILE







# INDEX

## **Accessories**

Bags	4
Covers	9
Seats	13
Windshields & Mirrors	15
Protection & Grips	19
Suspensions, Slides & Wheels	23
Runners & Skis	27
Essentials & General	32

# BAGS



---

Sidewinder & SRViper

## WINDSHIELD GEAR BAG

---

SMA-8MS21-00-BK

---

This pack does double duty as both a sleek windshield and convenient storage for small items.

- Semi-rigid construction
- Water resistant
- Large zipper pull tabs easy to open and close with gloves on
- Perfect for mountain and back-country riders



---

Sidewinder & SRViper

## MEDIUM TUNNEL GEAR BAG

---

SMA-8MB63-00-BK

---

Add some extra storage to your sled while retaining its sleek styling.

- Features semi-rigid construction with water resistant zippers
- Large pull tabs ensure you can open the bag with gloves on
- Installs quickly with our 1/4 turn fastener system





Sidewinder & SRViper

### WINDSHIELD GEAR BAG

SMA-8LR21-00-BK

Offers convenient, easy-access storage for the smaller essentials you need to take our on the trails.

- Made of durable, weather resistant nylon with colored accent material
- Perfect for phones, keys, wallet, camera, small tools, etc.
- Uses windshield screws for mounting



Sidewinder & SRViper

### EXTRA LARGE TUNNEL GEAR BAG

SMA-8MB65-00-BK

Add some extra storage to your sled while retaining its sleek styling.

- Features semi-rigid construction with water resistant zippers
- Large pull tabs ensure you can open the bag with gloves on
- Installs quickly with our 1/4 turn fastener system



SXVenom, SXVenom Mountain, RSventure TF, Transporter Lite, Transporter Lite 2UP, Siderwinder SRX LE, Sidewinder S-TX GT EPS

### HANDLEBAR BAG

SMA-8LY43-00-00

Add some convenient storage to your sled with this multi-compartment bag. Mounts using both the handlebar and handlebar risers.

- Made of durable, weather resistant nylon.



Sidewinder & SRViper

### HANDLEBAR BAG

SMA-8JP43-01-00

Add some convenient storage to your sled with this multi-compartment bag.

- Mounts using both the handlebar and handlebar risers
- Durable, weather resistant nylon



SnoScoot 200

### HANDLEBAR BAG

SMA-8ML21-00-00

Add some convenient storage to your sled.

- Simple secure installation to the handlebars



Sidewinder & SRViper

### LARGE TUNNEL GEAR BAG

SMA-8MB64-00-BK

Add some extra storage to your sled while retaining its sleek styling.

- Features semi-rigid construction with water resistant zippers
- Large pull tabs ensure you can open the bag with gloves on
- Installs quickly with our 1/4 turn fastener system



**SRViper 2020**  
**GOGGLE HOLDER**

SMA-8JP53-00-00

Dry out your goggles, masks or gloves with the heat of the engine while you ride.

- Durable, weather resistant 1000 denier nylon with mesh bottom
- Mounts in-between the steering post and instrument panel

*NOTE: Do not leave items in the holder for extended periods of time, as excessive heat may cause damage*



**Sidewinder & SRViper**  
**GOGGLE HOLDER**

SMA-8LR53-00-00

Dry out your goggles, masks or gloves with the heat of the engine while you ride.

- Durable, weather resistant 1000 denier nylon with mesh bottom
- Mounts in-between the steering post and instrument panel

*NOTE: Do not leave items in the holder for extended periods of time, as excessive heat may cause damage*



**Sidewinder & SRViper**  
**YAMAHA COMBINATION TRUNK BAG**

SMA-8LR63-00-BK

Increase your luggage space with options to spare and plenty of compartments to keep your items organized the way you want them.

- Tunnel bag with saddlebags combination
- Multi-compartment design
- Durable, weather resistant nylon
- Will not work in conjunction with the Two-Up Seat



**SRViper & Sidewinder X-TX, B-TX & M-TX**  
**TUNNEL GEAR BAG**

SMA-8KG63-00-00

Simple water-resistant moulded top tunnel pack perfect for the mountains.

- Mounts with quick attach straps to the rear grab bar
- 35 x 23 x 18 cm



**Sidewinder & SRViper**  
**YAMAHA TUNNEL GEAR BAG**

SMA-8LY63-00-BK

- Expandable top
- Mounts to the tunnel and under the seat
- Durable, weather resistant 1680 denier nylon



**Sidewinder & SRViper**  
**YAMAHA SADDLEBAGS**

SMA-8LR73-00-BK

When you need to bring along extra gear for your ride, these saddlebags provide that extra essential storage capability.

- Two large bags, one on each side of the seat/tunnel
- Mounts to the tunnel and under the seat
- Durable, weather resistant nylon and colored accent material
- Sold in pairs
- Black/Carbon Fiber





VK540

### REAR CARGO BAG

SMA-8KX63-00-00

Perfect for when you need to bring along extra gear for your ride.

- Large storage capacity
- Two side pockets
- Easily on-and-off
- Black



Sidewinder & SRViper

### SEAT PACK

SMA-8JR63-00-00

Get that extra bit of storage you need while maintaining the original profile of your sled.

- Multi-compartment design
- Mounts to the tunnel and under the seat
- Durable, weather resistant nylon and coloured accent material



MP600 Transporter 2019

### LARGE PLASTIC BOX ON LUGGAGE HOLDER

ACC6001000

Add some extra storage to your sled while retaining its sleek styling.

- Features rigid plastic construction with water resistant list
- Large locking handles and really strong hinges. Installs quickly without need to remove 2-up seat if eventually mounted



Sidewinder, SnoScoot, SRX120

### DELUXE TUNNEL PACK

SMA-8JX63-00-00

Pack a snack and extra essentials for that long or short ride.

- Semi-rigid bag
- Easily removable



Sidewinder & SRViper

### YAMAHA EXPANDABLE RACK PACK

SMA-8JY63-00-00

Perfect for when you need to bring that extra gear on your ride.

- Large capacity storage
- Quick-attach straps
- Fits in the Tunnel Rack, sold separately



Sidewinder & SRViper

### YAMAHA HARD SADDLEBAGS

SMA-8LN73-00-00

Perfect large-capacity storage solution for those long rides. Protects your cargo and essentials from the elements while out on the trails.

- Injection-moulded
- Clean, streamlined look
- Lockable - includes two keys with locks
- 12 liter per bag
- Quick-release attachment
- Sold as a pair
- 53 x 25 x 20 cm





Sidewinder & SRViper R-TX, L-TX, X-TX

## TUNNEL RACK BLACK

SMA-8JPRK-10-BK

Bring any extra items you need along for the ride.

- Allows you to easily secure your gear with bungee cords or other types of lines (not included)
- Requires Rear Grab Bar & Hitch Kit, sold separately
- All hardware included





# COVERS



---

**SRX120**

## **CUSTOM STORAGE COVER**

---

SMA-8MV29-00-00

Protects your unit from the elements during storage.

- Custom fit cover
- Durable solution dyed polyester
- Provides extra UV protection to minimize fading and material breakdown
- Handlebar reinforcements
- Spindle straps and rear securing strap



---

**Snoscoot 200**

## **CUSTOM STORAGE COVER**

---

SMA-8ML29-00-00

Protects your unit from the elements during trailering or storage.

- Strong 300D solution dyed polyester
- Expandable windshield pocket fits all accessory windshields
- Duraflex buckle system to keep cover snug to unit
- Soft inner liner protects hood from marking while trailering



**Sidewinder & SRViper B-TX & M-TX  
CUSTOM STORAGE COVER**

SMA-8MR29-00-00

Protects your unit from the elements during trailering or storage.

- Strong, preshrunk, two-ply army duck canvas that's been specially finished to resist water, and mildew
- Cotton canvas is naturally very soft on the finish of your unit and conforms like a pair of jeans, will also vent moisture away
- An expandable windshield panel will accommodate the taller accessory windshields
- Add Undercover Protector to protect windshield and shroud area, sold separately



**SRViper & Sidewinder 2019  
CUSTOM COVER 2-UP SEAT**

SMA-8MU30-00-00

Made of strong, preshrunk, two-ply army duck canvas that's been specially finished to resist water and mildew.

- Cotton canvas is naturally very soft on the finish of your snowmobile and conforms like a pair of jeans — this material also vents moisture better than other material on the market
- Covers feature Yamaha Genuine graphics
- Includes sewn-in soft undercover to protect your sled's finish while trailering
- Cover not exactly shown, picture representative of cover graphics



**Transporter Lite, Transporter Lite 2UP, SXVenom, SXVenom Mountain  
2UP COVER**

SMA-8NX29-00-00

The cover protects your unit from the elements during trailering or storage. Back-coated with urethane, it provides an excellent barrier to the elements and road grime.

- Made of premium SurLast® polyester fabric, which is very UV, and colour stable.
- Has an expandable windshield panel will accommodate the taller accessory windshields.
- May not be exactly as shown in photo.



**Sidewinder & SRViper L-TX, S-TX & X-TX  
CUSTOM STORAGE COVER**

SMA-8MB29-00-00

Protects your unit from the elements during trailering or storage.

- Strong, preshrunk, two-ply army duck canvas that's been specially finished to resist water, and mildew
- Cotton canvas is naturally very soft on the finish of your unit and conforms like a pair of jeans, will also vent moisture away
- An expandable windshield panel will accommodate the taller accessory windshields
- Add Undercover Protector to protect windshield and shroud area, sold separately



**VK540 2017  
CUSTOM STORAGE COVER**

SMA-8KX29-00-00

Protects your unit from the elements during trailering or storage.

- Strong 300D solution dyed polyester
- Zippered gas opening
- Expandable windshield pocket
- Includes undercover felt protection around windshield and shroud area
- Duraflex buckle system to keep cover snug to unit.

*Note! Does not cover backrest and luggage holder.*



**Sidewinder & SRViper L-TX, S-TX & X-TX  
DELUXE STORAGE COVER**

SMA-8MB30-00-00

Protects your unit from the elements during trailering or storage.

- Premium SurLast® polyester fabric, which is very UV, and colour stable
- Back-coated with urethane to provide an excellent barrier to the elements and road grime
- Includes soft, sewn in polyester undercover that helps protect your unit's finish while storing and transporting
- An expandable windshield panel will accommodate the taller accessory windshields





#### RS VIKING 2016

### CUSTOM STORAGE COVER

SMA-8KW29-00-00

Protects your unit from the elements during trailering or storage.

- Strong, preshrunk, two-ply army duck canvas that's been specially finished to resist water, and mildew
- Cotton canvas is naturally very soft on the finish of your unit and conforms like a pair of jeans, will also vent moisture away
- An expandable windshield panel will accommodate the taller accessory windshields
- Add Undercover Protector to protect windshield and shroud area, sold separately.

*Note! Does not cover backrest and luggage holder.*



#### Sidewinder L-TX & X-TX LE

### CUSTOM STORAGE COVER LIMITED EDITION

SMA-8MM30-LE-00

This limited edition cover is made from a premium Sur Last® polyester fabric and is very UV and color stable. It is back-coated with urethane to provide an excellent barrier to the elements and trail grime. Includes sewn-in soft, washable polyester undercover to protect your sled's finish while trailering. Unique cover design to match the graphics on Hi-Vis Sidewinder models.



#### SRViper M-TX

### CUSTOM STORAGE COVER

SMA-COVER-88-00

Our custom covers are made of strong, preshrunk, two-ply army duck canvas that been specially finished to resist water and mildew.

- Cotton canvas is naturally very soft on the finish of your snowmobile and conforms to your sled like a pair of jeans. This material also vents moisture better than other material on the market.
- These covers are black with genuine Yamaha graphics.



#### RSVenture 2009

### CUSTOM STORAGE COVER

SMA-COVER-56-00

Protects your unit from the elements during trailering or storage.

- Strong, preshrunk, two-ply army duck canvas that's been specially finished to resist water, and mildew
- Cotton canvas is naturally very soft on the finish of your unit and conforms like a pair of jeans, will also vent moisture away
- An expandable windshield panel will accommodate the taller accessory windshields
- Add Undercover Protector to protect windshield and shroud area, sold separately



#### Sidewinder S-TX 146 GT

### CUSTOM STORAGE COVER

SMA-8MJ29-00-00

Protects your unit from the elements during trailering or storage.

- Strong, preshrunk, two-ply army duck canvas that's been specially finished to resist water, and mildew
- Cotton canvas is naturally very soft on the finish of your unit and conforms like a pair of jeans, will also vent moisture away
- An expandable windshield panel will accommodate the taller accessory windshields
- Add Undercover Protector to protect windshield and shroud area, sold separately.

*Note! Does not cover backrest and 2-up Seat*



#### Venture Multi Purpose

### CUSTOM STORAGE COVER

SMA-COVER-74-00

Our custom covers are made of strong, preshrunk, two-ply army duck canvas that been specially finished to resist water and mildew.

- Cotton canvas is naturally very soft on the finish of your snowmobile and conforms to your sled like a pair of jeans. This material also vents moisture better than other material on the market.
- These covers are black with genuine Yamaha graphics.



MP600 & MP800 Transporter

### CUSTOM STORAGE COVER

SMA-8ND30-00-00

Protects your unit from the elements during trailering or storage.

- Strong, preshrunk, two-ply army duck canvas that's been specially finished to resist water, and mildew
- Cotton canvas is naturally very soft on the finish of your unit and conforms like a pair of jeans, will also vent moisture away
- Add Undercover Protector to protect windshield and shroud area, sold separately

**Note! Does not cover backrest and 2-up Seat.**



MP600 & MP800 Transporter

### CUSTOM STORAGE COVER

SMA-8ND40-00-00

Protects your unit from the elements during trailering or storage.

- Strong, preshrunk, two-ply army duck canvas that's been specially finished to resist water, and mildew
- Cotton canvas is naturally very soft on the finish of your unit and conforms like a pair of jeans, will also vent moisture away
- Add Undercover Protector to protect windshield and shroud area, sold separately
- Fits unit with 2-up Seat.

**disclaimer: image does not show 2-up seat.**



Mountain Max 154

### STORAGE COVER

SMA-8NS30-LE-00

Protects your unit from the elements during trailering or storage. The back is coated with urethane to provide an excellent barrier to the elements and road grime. It includes soft, sewn in polyester undercover that helps protect your unit's finish while storing and transporting. It has an expandable windshield panel that will accommodate the taller accessory windshields.

- Made of premium, UV resistant Polyester
- Matches the graphics on the Mountain Max





# SEATS



---

**MP600 & MP 800 Transporter**

---

## **2UP SEAT KIT**

---

SMA-8ND98-00-00

Converts your sled to carry a passenger

- Includes passenger seat with bracket, handholds and footrests
- Accepts Cargo Racks and Tunnel Bags.



---

**Transporter Lite**

---

## **OVERLOAD SPRING KIT**

---

SMA-8NU35-00-00

Stiffens rear suspension when carrying a passenger or heavy loads.

- Sold in pairs.

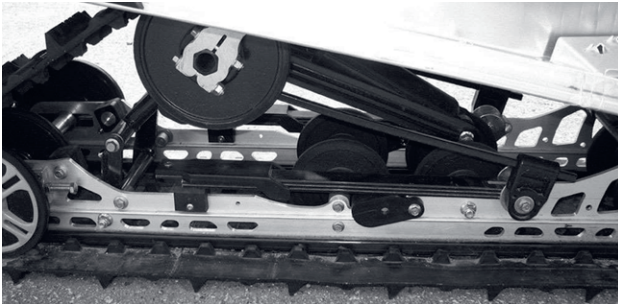

MP600 & MP 800 Tranporter, Sidewinder 146 GT

### OVERLOAD SPRING KIT

SMA-8LN35-01-00

Stiffens rear suspension when carrying a passenger or heavy loads.

- Recommended to use when load exceeds 300 lb
- Sold in pairs
- Also fits SR Viper S-TX 146 DX



SRViper & Sidewinder X-TX, L-TX, B-TX

### 2-UP SEAT

SMA-8JP2P-ST-01

Convert your sled to allow you to carry a passenger.

- Includes passenger seat with adjustable handholds, quick-release footrests, and optional heated grip warmers (requires Heated Grip Warmer Switch Kit, sold separately)
- Accepts rear rack or bag
- Requires Rear Grab Bar & Hitch Kit for installation, sold separately
- Will not work in conjunction with Combination Trunk Bag



SRViper

### HEATED SEAT KIT

SMA-8JP97-00-BK

Make your ride more comfortable by providing your body with extra warmth from this heated seat kit.

- Comes with new laminated seat cover, wiring kit and switch.
- Professional installation recommended.



Transporter Lite

### 2-UP SEAT

SMA-8NU49-00-00

Convert your snowmobile to allow you to carry a passenger.

- Matches the unit design





# WINDSHIELD & MIRRORS

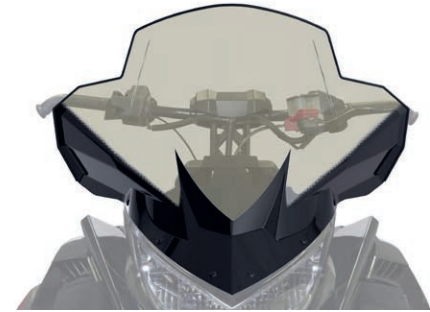

**SRViper & Sidewinder**

## **MEDIUM WINDSHIELD**

SMA-8LR96-30-SM

Adds both style and function while offering up even more wind protection for those especially cold days on the trail. Gives a custom look to the front profile of the sled.

- Made of smoke polycarbonate with black silk screening
- 47 cm
- Accepts windshield mirrors, sold separately, (SMA-8LJ26-00-00)
- Smoke



**SRViper & Sidewinder**

## **MEDIUM SPORT WINDSHIELD**

SMA-8LR96-21-SM

Adds both style and function while offering up even more wind protection for those especially cold days on the trail. Gives a custom look to the front profile of the sled.

- Made of smoke polycarbonate with black silk screening
- 42 cm
- Accepts windshield mirrors, sold separately (SMA-8LJ26-00-00)
- Smoke



SRViper & Sidewinder

### LOW WINDSHIELD

SMA-8LR96-10-SM

Low profile, and aerodynamic windscreen complements the aggressive profile of the sled's front end.

- Made of smoke polycarbonate with black silk screening
- 26 cm
- Smoke



SRViper & Sidewinder

### TALL WINDSHIELD

8MH-K7210-00-00

Customizes the look of your sled and offers additional wind protection.

- Made of polycarbonate
- 49 cm
- Clear



SRViper & Sidewinder

### TALL WINDSHIELD

SMA-8LR96-20-SM

Customizes the look of your sled, and offers additional wind protection.

- Made of polycarbonate
- 49 cm
- Smoke

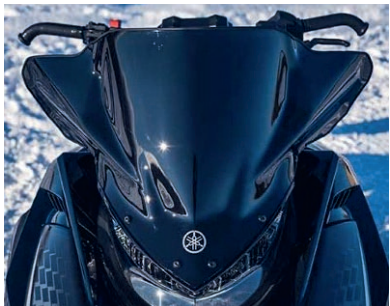

SRViper & Sidewinder

### LOW SPORT WINDSHIELD

SMA-8JP96-11-BK

Provides improved protection over stock.

- Adds a splash of color with racing inspired graphics
- 37 cm
- Black



SRViper & Sidewinder

### LOW SPORT WINDSHIELD

SMA-8JP96-11-RD

Provides improved protection over stock.

- Adds a splash of color with racing inspired graphics
- 37 cm
- Red



SRViper & Sidewinder

### LOW SPORT WINDSHIELD

SMA-8JP96-11-BL

Provides improved protection over stock.

- Adds a splash of color with racing inspired graphics
- 37 cm
- Blue





SRViper 2014-2019

### MEDIUM WINDSHIELD

SMA-8JP96-20-00

Customizes the look of your sled, and offers additional wind protection.

- Made of polycarbonate
- 52 cm
- Clear



Sidewinder

### LOW SPORT WINDSHIELD RED

SMA-8MY96-11-RD

For improved protection over stock windshield.

- 37 cm tall
- Yamaha Red



Windshields SRViper & Sidewinder

### EXTREME LOW WINDSHIELD

SMA-8JP96-00-RD

For SR Viper riders looking for a super low windshield, these colored windshields fit the bill while providing an upgraded look.

- Made of back-painted clear plastic
- 17 cm
- Red



SRViper & Sidewinder

### EXTREME LOW WINDSHIELD

SMA-8JP96-00-BK

For SR Viper riders looking for a super low windshield, these colored windshields fit the bill while providing an upgraded look.

- Made of back-painted clear plastic
- 17 cm
- Black



SRViper 2014-2019

### TALL WINDSHIELD

SMA-8JP96-30-00

Helps deflect wind and snow for taller riders or those who prefer a more upright riding position.

- Made of polycarbonate
- 69 cm
- Clear



Windshields Mirror kit SRViper & Sidewinder

### WINDSHIELD MIRROR KIT

SMA-8LJ26-00-00

Accentuates the sporty styling of your sled while helping you stay aware of your surroundings.

- Mounts to outside of windshield
- Works with the Medium Sport Windshield (SMA-8LR96-21-SM) and the Medium Windshield (SMA-8LR96-30-SM) only, sold separately.



SRViper 2014-2019

### MEDIUM WINDSHIELD

SMA-8JP96-20-SM

Customizes the look of your sled, and offers additional wind protection.

- Made of polycarbonate
- 52 cm
- Smoke



SnoScoot ES, SRX120

### MID HEIGHT WINDSHIELD

SMA-8ML96-20-00

Helps deflect wind and snow from rider.

- Sleek profile matches style of machine
- Made of a high-quality polycarbonate
- Clear



SnoScoot ES, SRX120

### TALL WINDSHIELD

SMA-8ML96-30-00

Offers significant increase in wind protection.

- Helps deflect snow and wind from rider
- Made of a high-quality polycarbonate
- Clear





# PROTECTION & GRIP



---

**Sidewinder**

## **CONSOLE KNEE PADS**

---

SMA-8LR24-00-BK

---

Add comfort and extra grip for your knees while protecting your machine's bodywork from scuffing.

- Heavy-duty durable nylon construction
- Mounts to snowmobile securely
- Cushioned pads
- Sold in pairs



---

**SRViper**

## **CONSOLE KNEE PADS**

---

SMA-8JP24-00-WH

---

The Console Knee Pads add comfort and extra grip for your knees. These cushioned pads also help to protect your tank shroud from scuffing.

**Also fits Sidewinder M-TX**



SRViper 2014-2019

### REAR SKID PLATE

SMA-8JP34-RR-BK

Gives full coverage protection for your clutch, exhaust, and chain case components.

- Can be used with Front Skid Plate or Sport Front Grab Bar, both sold separately
- Black



SRViper 2014-2019

### FRONT SKID PLATE

SMA-8JP34-FR-BK

Improves approach angle and protects the nose cone from damage by stumps, rocks, ice chunks and other debris.

- Can be combined with Rear Skid Plate, sold separately
- Will not work in conjunction with Sport Front Grab Bar
- Black
- Fits SRViper only



Sidewinder & SRViper

### PRO SKID PLATE

SMA-8LR34-00-BK

Race-inspired design that offers lightweight protection from stumps, rocks, ice chunks, and other trail debris that can damage the bottom of the chassis.

- Durable UHMW construction
- Includes all mounting hardware.



SRViper

### FLOTATION SKID PLATE

SMA-8KC34-00-BK

Adds the maximum amount of protection and additional floatation, helping the snowmobile float through the powder.

- Durable UHMW construction
- Includes all mounting hardware
- Does not fit up with optional accessory front bumpers
- Fits SRViper 2014-2019

*Note! Does not fit SRViper 2020-2021*



Sidewinder

### REAR TRAIL SKID PLATE

SMA-8LR34-RR-BK

Gives full coverage protection for your clutch, exhaust, and chain case components.

- 1/4" thick high molecular weight polyethylene
- Fits all Sidewinder except M-TX



Sidewinder M-TX

### REAR MTX SKID PLATE

SMA-8MP34-00-BK

Gives full coverage protection for your clutch, exhaust, and chain case components.

- 1/4" thick high molecular weight polyethylene.
- Fits Sidewinder M-TX 2018-2021





**MP600 Transporter**

### REAR SKID PLATE

SMA-8ND34-00-BK

Gives full coverage protection for your clutch, exhaust, and chain case components.

- 1/4" thick high molecular weight polyethylene.



**Sidewinder & SRViper**

### SWITCH GUARDS

SMA-8KG86-00-00

Helps prevent accidental shut off of control switches.

- Hand /thumb warmer guard
- Stop switch guard
- Adhesive



**SRViper**

### HEATED GRIP WARMER SWITCH KIT

SMA-8JP2P-ST-WH

Required for passenger hand warmers on the Two-Up Seat, sold separately.

- Includes wire harness with disconnect coupler and passenger control switch



**Mountain Max 154**

### MOUNTAIN REAR SKID PLATE

SMA-8NS34-00-00

Gives full coverage protection for your clutch, exhaust, and chain case components.

- May not be exactly as shown in photo.



**Transporter Lite 2UP, Transporter Lite, SXVenom Mountain, Sidewinder B-TX LE 153, SXVenom Mountain**

### SKID PLATE

SMA-8NU34-00-00

Gives full coverage protection for your clutch, exhaust, and chain case components.

- May not be exactly as shown in photo.



**SnoScoot 200 & SRX120**

### RUNNING BOARD GRIPS

SMA-8MLS7-00-BK

Allows maximum grip in all snow conditions.

- Adds additional rows of grip to edges of running board as well as center section.



Sidewinder SRX 2022

### GRAPHIC KIT (HANDGUARD)

SMA-8MY70-RD

Matches production graphics for a custom look.

- White / Red /Regal Gold match 2022 Sidewinder SRX models
- Handguards (SMA-8LYHG-00-BK) and Mounts (SMA-8LYMT-00-00) sold separately



Sidewinder SE 2022

### GRAPHIC KIT (HANDGUARD)

SMA-8MA70-00-BL

Matches the production graphics for a custom look.

- Ice Blue /Jet Orange Colours match 2022 Sidewinder SE models
- Handguards (SMA-8LYHG-00-BK) and Mounts (SMA-8LYMT-00-00) sold separately



Sidewinder LE 2022, SXVenom

### GRAPHIC KIT (HANDGUARD)

SMA-8NT70-00-BL

Matches production graphics for a custom look.

- Silver Frost / Yamaha Racing Blue matches 2022 Sidewinder LE, SXVenom.
- Mountain Max models Handguards (SMA-8LYHG-00-BK) and Mounts (SMA-8LYMT-00-00) sold separately.





# SUSPENSIONS, SLIDES & WHEELS



---

## **SPOKED STYLE REAR AXLE GUIDE WHEEL**

---

SMA-8HF38-02-BK

---

Add some style and colour to your sled.

- Constructed of plastic
- 178 mm
- 6004 bearing included
- Sold individually
- Black



---

## **SPOKED STYLE IDLER BOGEY WHEEL**

---

SMA-8HF38-01-BK

---

Add some style and color to your sled.

- Constructed of plastic
- 130 mm
- 6005 bearing included
- Sold individually
- Black



### Spoked Style Idler Bogey Wheel

SMA-8HF38-01-SL

Add some style and color to your sled.

- Constructed of plastic
- 130 mm
- 6005 bearing included
- Sold individually
- Silver

*Please Note! Will be discontinued! Sell out!! Pre order only.*



### Closed Rear Axle Guide Wheel

8DF-47550-01-00

Add some style and color to your sled.

- Constructed of plastic
- 178 mm
- Bearing included
- Sold individually
- Black



### Closed Rear Axle Guide Wheel

8DF-47550-01-SL

Add some style and color to your sled.

- Constructed of plastic
- 178 mm
- Bearing included
- Sold individually
- Silver

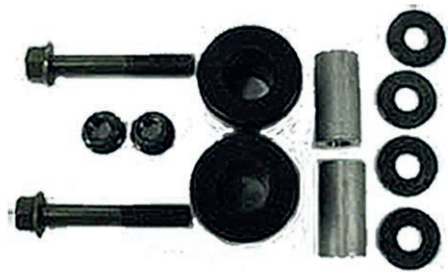

### Anti-Bottoming Kit

SMA-BUMPS-TO-PS

Allows you to further fine tune your rear suspension.

- Rubber pillow blocks bolted to the rail are used to engage the rear torsion spring farther up as the suspension moves through the latter part of its stroke
- Effectively increases the leverage ratio of the spring against the load to help reduce suspension bottoming without effecting small bump compliance (ride comfort) when the skid frame is in its initial (beginning) stroke.
- Fits older models and Phazer.



### SRViper & Sidewinder Rear Fourth Wheel Kit

SMA-8JY47-00-BK

Outside idler wheels help keep track in proper alignment and spreads load evenly across the entire track.

- Wheels
- Spacer blocks
- All necessary hardware
- 8.0" x 0.787"
- Black



### SNOSCOOT ES Heavy-Duty Suspension Springs

SMA-8ML35-00-00

Upgrade your suspension with stiffer springs designed to resist bottoming.

- 2 rear torsion springs
- 2 ski shock springs





SRViper & Sidewinder

### DUPONT SLIDE

SMA-DPSSV-MT-00

Perfect for everyday riding on the trails or in the mountains.

- Reduces the friction and protects the aluminum rails from track wear. DuPont Vespel® material inserts
- Space-age polymer/composite material, that is stronger than hardened steel, aluminum, or even titanium
- Pieces are placed at a 30-degree angle across the entire slider for constant contact and even wear
- Lightweight, yet strong
- Sold individually. 174"



### OMC Original Slides "fitting list"

8KG-G7421-00-00 fits 8KG4, 8KS2, 8KT2, 8MF2, 8MG2.  
 8KG-G7421-10-00 fits 8LH5, 8MF4, 8MF6, 8MS2, 8MS3, 8MX1.  
 8KT-G7421-00-00 fits 8KC2, 8KU2.  
 8KT-G7421-10-00 fits 8MT2, 8MT5.  
 8JE-47421-00-00 fits 8JE1, 8JE3, 8KB1, 8KW1, 8KW3, 8LP1, 8LP3.  
 8AC-47421-00-00 fits VK540 2003-2012 & RS/VK 2006-2012.  
 8JD-47421-01-00 fits VK540 2013-2019.  
 8JR-G7421-00-00 fits 8JRD, 8JR4, 8KR2, 8LH2, 8MD2, 8MD4, 8ME2.  
 8JR-G7421-10-00 fits 8MW1, 8NB1.  
 8JX-G7421-00-00 fits 8JY3, 8KP2, 8LY5, 8MC2, 8MM2.  
 8GC-47421-00-00 fits Phazer 2007-2015.  
 8HA-47421-00-00 fits FX Nytro M-TX 2008-2009.  
 8HL-47421-00-00 fits 8HL2, 8HL4, 8HN2  
 8HU-47421-00-00 fits FX Nytro M-TX 153 2012-2014.  
 8HR-47421-00-00 fits FX Nytro M-TX 162 2010-2014.  
 8FM-47421-00-00 fits RS Venture TF 2005-2013.  
 8FM-47421-10-00 fits RS Venture TF 2014-2019.  
 8ET-47421-00-00 fits Venture MP 2011-2019.  
 8JM-G7421-00-00 fits All SRX120.  
 8ML-G7421-00-00 fits All Snoscoot.



SRViper & Sidewinder

### DUPONT SLIDE

SMA-8JPD-SS-00

Perfect for everyday riding on the trails or in the mountains.

- Reduces the friction and protects the aluminum rails from track wear. DuPont Vespel® material inserts
- Space-age polymer/composite material, that is stronger than hardened steel, aluminum, or even titanium
- Pieces are placed at a 30-degree angle across the entire slider for constant contact and even wear
- Lightweight, yet strong
- Sold individually. 141"



### HIGH-PERFORMANCE SLIDE

SMA-8HR92-00-HP

Reduces friction, and protects the aluminum rails from track wear.

- Special plastic and graphite blend material provides an extra slippery surface for high performance
- Sold individually
- 162"



SRViper & Sidewinder

### DUPONT SLIDE (OLDER UNITS)

SMA-DPSSR-00-00

Perfect for everyday riding on the trails or in the mountains.

- Reduces the friction and protects the aluminum rails from track wear. DuPont Vespel® material inserts
- Space-age polymer/composite material, that is stronger than hardened steel, aluminum, or even titanium
- Pieces are placed at a 30-degree angle across the entire slider for constant contact and even wear
- Lightweight, yet strong
- Sold individually. 144"
- FITS ALL EXCEPT SRViper & Sidewinder.



### HIGH-PERFORMANCE HYFAX SLIDE

SMA-8EP92-70-HP

Reduces friction, and protects the aluminum rails from track wear.

- Special plastic and graphite blend material provides an extra slippery surface for high performance
- Sold individually
- 162"





Sidewinder SRX LE, Sidewinder S-TX GT EPS, RSventure TF, SRViper LE 153, Sidewinder X-TX SE, VKProfessional II EPS, Sidewinder M-TX LE 153

## SUSPENSION BLOCK

SMA-8JP39-BL10

Helps you achieve the ride quality that you want by allowing custom tuning of your rear suspension to 4 levels of spring preload.

- Made from solid billet aluminum.
- Anodized for long life. Sold in pairs.



# RUNNERS & SKIS



SRViper & Sidewinder. B-TX, M-TX & X-TX 141 LE

## WOODY'S 6" ACE RUNNER SET

SMA-AY688-00-00

Works great when riding in deep snow.

- 6" of 60° turning carbide on a tall, square host bar
- Sold in pairs.



SRViper & Sidewinder. B-TX, M-TX & X-TX 141 LE

## WOODY'S 8" ACE RUNNER SET

SMA-AY888-00-00

Works great when riding in deep snow.

- 8" of 60° turning carbide on a tall, square host bar
- Sold in pairs.





SRViper & Sidewinder. B-TX, M-TX & X-TX 141 LE  
**WOODY'S TRAIL BLAZER IV RUNNER SET**

SMA-TYV48-80-00

Great if you're looking for overall improvement in handling to replace your stock runner.

- 6" of 60° carbide on a 1/2" diameter host bar
- Use with a studded or un-studded track
- Sold in pairs.



SRViper & Sidewinder. X-TX 141 SE, L-TX, S-TX & R-TX  
**WOODY'S TRAIL BLAZER IV RUNNER SET**

SMA-TYV48-50-00

Great if you're looking for overall improvement in handling to replace your stock runner.

- 6" of 60° carbide on a 1/2" diameter host bar
- Use with a studded or un-studded track
- Sold in pairs.



SRViper & Sidewinder. X-TX 141 SE, L-TX, S-TX & R-TX  
**WOODY'S EXECUTIVE RUNNER SET**

SMA-KYV85-00-00

Suitable for competition and experienced riders.

- 8" of 60° carbide on 1/2" diameter host bar
- Carbide must be balanced with a studded track
- Sold in pairs.



SRViper & Sidewinder X-TX 141 SE, L-TX, S-TX & R-TX  
**WOODY'S EXTENDER TRAIL III RUNNER SET**

SMA-EYV38-50-00

Perfect for trail touring.

- 4" of 60° carbide on 7/16" diameter host bar
- Use with a lightly studded or un-studded track
- Sold in pairs.



VK540, RS Venture, RS Viking older than 2012  
**PERFORMANCE X-10 TWO RUNNER**

SMA-8EN10-21-00

For hard riding on varying terrain.

- 6" of 90° carbide on 7/16" host bar
- Sold in pairs.
- And other older models.



RS Viking 2018  
**WOODY'S TRAIL BLAZER IV RUNNER SET**

SMA-TYV46-59-00

Great if you're looking for overall improvement in handling to replace your stock runner.

- 6" of 60° carbide on a 1/2" diameter host bar
- Use with a studded or un-studded track
- Sold in pairs.



### WOODY'S TRAIL BLAZER IV RUNNER SET

SMA-TYV46-58-00

Great if you're looking for overall improvement in handling to replace your stock runner.

- 6" of 60° carbide on a 1/2" diameter host bar
- Use with a studded or un-studded track
- Sold in pairs.



SRViper 2014 & M-TX 2015-2016

### WOODY'S EXECUTIVE RUNNER SET

SMA-KAT99-75-00

Suitable for competition and experienced riders.

- 8" of 60° carbide on 1/2" diameter host bar
- Carbide must be balanced with a studded track
- Sold in pairs.

*Please Note! Will be discontinued! Sell out!! Pre order only.*



SRViper 2014 & M-TX 2015-2016

### WOODY'S TRAIL BLAZER IV RUNNER SET

SMA-TA499-75-00

Great if you're looking for overall improvement in handling to replace your stock runner.

- 6" of 60° carbide on a 1/2" diameter host bar
- Use with a studded or un-studded track
- Sold in pairs

*Please Note! Will be discontinued! Sell out!! Pre order only.*



SRViper 2014 & M-TX 2015-2016

### WOODY'S EXTENDER TRAIL III RUNNER SET

SMA-EAT99-75-00

Perfect for trail touring.

- 4" of 60° carbide on 7/16 diameter host bar
- Use with a lightly studded or un-studded track
- Sold in pairs.



SRViper 2014 & M-TX 2015-2016

### WOODY'S 6" DOOLY CARBIDE RUNNER

SMA-DA699-75-00

Improves handling on the snow surface by utilizing four traction lines which reduces darting as it makes its own groove in the trail.

- Each wear bar features two 7/16" runners with center carbide
- 6" of 90° carbide
- Sold individually.



SRViper 2014 & M-TX 2015-2016

### WOODY'S 8" DOOLY CARBIDE RUNNER

SMA-DA899-75-00

Improves handling on the snow surface by utilizing four traction lines which reduces darting as it makes its own groove in the trail.

- Each wear bar features two 7/16" runners with center carbide
- 8" of 90° carbide
- Sold individually.



**Snocoot ES**  
**CARBIDE RUNNER SET**

SMA-8ML31-02-00

Direct replacement of your stock runner to improve the overall handling of your unit.

- 2"
- Sold in pairs



**Sidewinder & SRViper**  
**STRYKE SKI KIT BLACK**

SMA-STRYK-BK-WH

Offers a perfect balance between lightweight steering effort and precision handling over a wide range of snow conditions.

- Kit includes two skis complete with handles and four ski shims
- Additional Ski loop colors available separately
- Carbides and Mounting hardware sold separately
- For added adjustment, various Styke Ski Shim Kit are sold separately.



**Sidewinder & SRViper**  
**STRYKE SKI KIT RED**

SMA-STRYK-RD-WH

Offers a perfect balance between lightweight steering effort and precision handling over a wide range of snow conditions.

- Kit includes two skis complete with handles and four ski shims
- Additional Ski loop colors available separately
- Carbides and Mounting hardware sold separately.
- For added adjustment, various Styke Ski Shim Kit are sold separately.



**VK540 & RS Viking**  
**SKI SKINS**

SMA-8FNSK-09-BK  
 SMA-8FNSK-11-BK

Increases ski flotation in deep snow conditions.

- Made of HDPE (high density polyethylene)
- Bolts directly to the stock ski
- Sold individually
- 23 cm resp. 28 mm wide
- Fits VK540 & RS Viking <-2017



**Sidewinder & SRViper**  
**STRYKE SKI KIT BLUE**

SMA-STRYK-BL-WH

Offers a perfect balance between lightweight steering effort and precision handling over a wide range of snow conditions.

- Kit includes two skis complete with handles and four ski shims
- Additional Ski loop colors available separately
- Carbides and Mounting hardware sold separately
- For added adjustment, various Styke Ski Shim Kit are sold separately



**Sidewinder & SRViper**  
**STRYKE SKI SHIM KIT**

SMA-SHIMS-KT-00

Fine tune the handling of your snowmobile equipped with STRYKE skis. These kits allow riders to fine tune the front and rear separately. If a rider finds they want to run the same size front-rear on the same ski they will require two shim kits.

- Includes three pairs of shims (2 x 2.5, 2 x 5.0, 2 x 7.5)
- Shims can be used in forward or rear position in ski





SRViper X-TX and B-TX and Sidewinder X-TX LE 146

### STRYKE SKI HANDLE

8MA-F3712-10-00 (Silver)  
8MA-F3712-20-00 (Ink Blue)  
8MA-F3712-30-00 (Orange)  
8MA-F3712-40-00 (Black)  
8MA-F3712-60-00 (Blue)

Designed specifically for the Stryke Skis, these handles allow you to match or contrast the color of your snowmobile.

- Uses stock hardware.
- Sold individually.



# ESSENTIALS & GENERAL



---

**Sidewinder L-TX 137 2019**

## **8-POCKET REAR GRAB BAR AND HITCH KIT**

---

SMA-8MH41-00-00

Strong, secure steel grab bar with pivot-style hitch.

- 8 mounting pockets
- All necessary hardware included
- Required to mount the Tunnel Rack, sold separately



---

**SRViper**

## **REAR GRAB BAR AND HITCH KIT X-TX,L-TX**

---

SMA-8JR41-01-00 also limited available in blue.

SMA-8JR41-01-BL (Picture N/A)

Strong, secure steel grab bar with pivot-style hitch.

- 4 mounting pockets
- All necessary hardware included
- Required to mount the Tunnel Rack, and Two-Up Seat Kit, both sold separately





**Sidewinder B-TX 153 2019**

### **8-POCKET REAR GRAB BAR AND HITCH KIT**

SMA-8MF41-00-00

Strong, secure steel grab bar with pivot-style hitch.

- 8 mounting pockets
- All necessary hardware included
- Also including hitch



**SRViper**

### **REAR GRAB BAR AND HITCH KIT R-TX**

SMA-8JP41-01-00

Strong, secure steel grab bar with pivot-style hitch.

- 4 mounting pockets
- All necessary hardware included
- Required to mount the Tunnel Rack, and Two-Up Seat Kit, both sold separately

*Please Note! Will be discontinued! Sell out!! Pre order only.*



**Sidewinder M-TX 153**

### **REAR GRAB BAR AND HITCH KIT R-TX**

SMA-8KG41-EX-00

Strong, secure steel grab bar with pivot-style hitch.

- 4 mounting pockets
- All necessary hardware included
- Required to mount the Tunnel Rack, and Two-Up Seat Kit, both sold separately

*Please Note! Will be discontinued! Sell out!! Pre order only.*



**Sidewinder M-TX 162**

### **REAR GRAB BAR AND HITCH KIT R-TX**

SMA-8KT41-EX-00

Strong, secure steel grab bar with pivot-style hitch.

- 4 mounting pockets
- All necessary hardware included
- Required to mount the Tunnel Rack, and Two-Up Seat Kit, both sold separately

*Please Note! Will be discontinued! Sell out!! Pre order only.*



**SRViper & Sidewinder**

### **PINTLE TOW CONVERSION KIT**

SMA-8JP79-10-00

Converts optional swivel hitch steel grab bar to a heavy-duty pintle-style hitch.

- Durable steel construction.
- Note! professional use, please use YFM91075 in conjunction with YFM91400 instead.



**SRViper & Sidewinder Tow hook**

### **PINTLE TOW CONVERSION KIT (Special for S-TX GT 146 )**

SMA-8LN79-10-00

Converts optional swivel hitch steel grab bar to a heavy-duty pintle-style hitch.

- Durable steel construction. Special adapted for S-TX GT 146. Can also be used on MP600 Transporter.





Fits most models

## HOOK HITCH

86D-77591-00-00

Simple style hook hitch for a rear tow bar.

- Durable steel construction



MP600 Transporter

## BPR FRONT GRAB BAR BK

SMA-8ND55-00-BK

Add more front end protection and a custom, sporty look to the front profile of the sled.

- Durable powder coated finish
- Includes all mounting hardware
- Black.

*Note! Does also fit SRViper X-TX 146 2020-2021*



Sidewinder

## FRONT GRAB BAR

SMA-8MT55-00-BK

Offers a solid grip and bold styling to the front of your snowmobile.

- Constructed of ultra-lightweight aluminum tubing
- Only weighs 1.5 kg



Transporter 600, Transporter Lite and Mountain Max 154

## FRONT GRAB BAR

SMA-8NS55-00-BK

Offers a solid grip and bold styling to the front of your snowmobile.

- Constructed of ultra-lightweight aluminum tubing



SRViper L-TX 2019

## SPORT FRONT GRAB BAR

SMA-8JWFT-BU-BK

Add more front end protection and a custom, sporty look to the front profile of the sled.

- All aluminum construction
- Durable powder coated finish
- Includes all mounting hardware
- Will not work in conjunction with Front Skid Plate
- Black.
- Fits also SRViper X-TX 2018 and older.

*Note! Does not fit SRViper 2020-2021*



VK540

## PASSENGER HAND WARMERS

SMA-8KXHP-PS-00

Provides excellent cold air protection for your passenger's hands.

- Water and wind resistant nylon outer
- Warm inner liner
- Easily attached with Velcro® straps



Fits most older units, except Sidewinder & SRViper

### WIND SHEAR WIND DEFLECTORS, BK

SMA-09HGC-BK-00

Offers additional wind protection and style for your sled. Semi-rigid design allows them to be installed directly onto your bare handlebars

- No need to install hand deflectors
- Black



SRViper & Sidewinder

### SNOW FLAP

SMA-8JP77-59-BK (Black)  
SMA-8JP77-59-BL (Blue)  
SMA-8JP77-59-RD (Red)

Add some style and flair by simply replacing the stock flap on your sled.

- Sold individually
- Black, Blue, Red.



SRViper & Sidewinder

### DELUXE HEATED SHIELD OUTLET

SMA-8LR10-00-00

Add a heated shield outlet to you machine.

- Dash mounted
- Equipped with cover to protect plug from ice, and snow
- Simple installation with factory accessory pig-tail



### ENGINE STOP TETHER

SMA-8JP81-00-00 (SRViper)  
SMA-8MS81-00-00 (Sidewinder)  
SMA-8ML81-00-00 (Snoscoot)

- Stops the engine In the event you get separated from your sled.
- End of the tether attaches to your jacket D-ring



All Phazer models

### HEAVY-DUTY STEERING BEARING KIT PHAZER

SMA-BEARI-NG-KT

Replaces the stock plastic bushing with this extreme duty roller bearing kit.

- Removes excessive free play in the steering caused by a worn out bushing

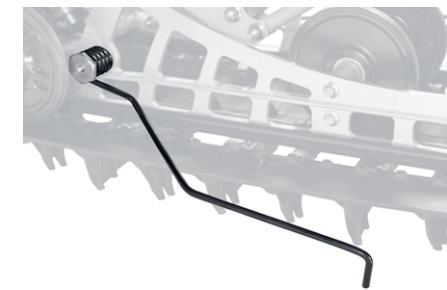

SRViper & Sidewinder

### ICE SCRATCHERS

SMA-8JP38-00-KT (SRViper & Sidewinder)

This handy device can make all the difference in promoting long hyfax life. Spring loaded scratchers drag in the snow creating a spray of ice chips into the skid frame, lubricating your hyfax.

- Allows for removal of wheels thus reducing sled weight
- When not in use, they simply hook over the rails
- Comes complete with drilling and installation instructions
- NOTE! Please Do not use in reverse!
- Sold in pairs

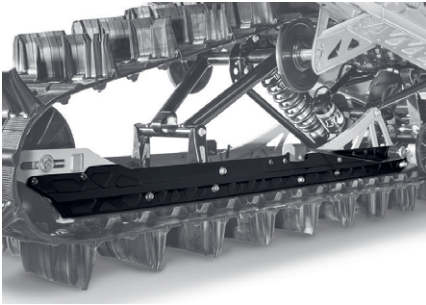

Fits 153" Rails

### Rail Brace kit

SMA-8MS60-BK-00

Designed with the hard-core riders in mind, these aluminum braces add strength to the stock rails.

- Reinforces entire mid-section of suspension rail to resist bending
- Aluminum brace with black finish
- Weighs 3.4 kg per pair.



### TRIC® ICE SCRATCHERS

SMA-ICESC-02-ST (Universal)

This kit scrapes frozen snow and sprays snow on the track rails to reduce rear slide wear and cool the engine. This projection of ice crystals lubricates the rear transmission of the snowmobile while acting as an additional cooling source for the radiators of the liquid cooled snowmobiles. Stainless steel mounting kit with universal mounting brackets included.

- Threaded replacement carbide claw (1/4" pitch US) supplied
- Also works in reverse
- Sold in pairs

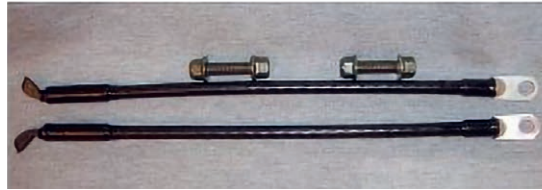

Fits most old models

### OMC YAMAHA ICE SCRATCHERS

8ET-W2378-09-00

Yamaha Wire type ice scratchers for mounting in e.g. front end.

- Sold as a pair.



Fits all except SRViper & Sidewinder

### TRIC® ICE SCRATCHERS studs

SMA-ICESC-CB-AP (Spare part)

- Replacement studs for your TRIC Scratcher.
- When ware down, replace studs, easy to just screw out.
- Sold as a pair.



Fits all except SRViper & Sidewinder

### SCORCHERS ICE SCRATCHERS

SMA-ICESC-BK-00 (Universal)

Lubricates hyfax and assists cooling when riding on hard-packed trails or frozen lakes.

- Stows away to a nested position when not in use
- Heat treated heavy-duty steel springs with anodized CNC machined, aircraft aluminum washers to ensure durability and high performance. Drilling may be required
- Can be used with or without idler wheels
- Should always be properly stowed. Failure to comply with these guidelines will result in damage.
- Sold as a pair.



Fits most models

### BILLET FUEL CAP

SMA-8MY67-00-BK (Black)  
SMA-8MY67-00-BL (Blue)  
SMA-8MY67-00-RD (Red)

For those who pay attention to the finer details of their sled, this stylish cap replaces stock for a more custom look.

- Made of billet aluminum.
- Clean design with a Laser-Etched Tuning Fork logo.

















**YAMAHA**  
Revs Your Heart

[www.yamaha-motor.eu](http://www.yamaha-motor.eu)

**YOU** YAMAHA MOTOR EXPERIENCE

**YOU** YAMAHA MOTOR SERVICES

Follow us on:



Dealer

**Yamaha Motor Europe N.V.**

Koolhovenlaan 101  
1119 NC Schiphol-Rijk  
P.O.Box 75033  
1117 ZN Schiphol  
The Netherlands  
+ 31 20 654 6000

Snowmobiles are built to operate within their design limits. For durability, reliability, but most important of all, operator safety, under no circumstances should the recommended capacities identified in the owner's manual be exceeded. Consult your snowmobile dealer when selecting a snowmobile for your particular needs. Always wear a helmet, eye protection and protective clothing. Always ride responsibly and within your limitations, respecting the environment as well as country and local laws. The riders depicted are professionals; don't attempt to emulate them. The specifications, measurements and appearance of Yamaha products will be varied from time to time without notice, and as shown here are illustrative only and are not a contractual description of products. Some models are shown with optional accessories. This document contains many of the valuable trademarks and service marks owned and used by Yamaha throughout the world. These company, brand and product names are used herein for identification purposes only, and references to any names, marks, products or services of third parties do not constitute or imply endorsement, sponsorship or recommendation of the third party or the products or services.

**YAMAHA**  
GENUINE  
Parts & Accessories

**YAMALUBE**

**YAMAHA-RACING.COM**  
/yamaharacing.com