

INTRODUCING POLARIS® POWER™ PORTABLE GENERATORS

- + Digital Inverter
- + Fuel Efficient
- + Quiet
- + Compact
- + Lightweight
- + 21-Hour Run-Time
- + Highly Portable
- + 3-Year Limited Warranty



All riders pictured are trained professionals. Polaris® recommends that all riders take a training course. Do not attempt maneuvers beyond your capability. Always wear a helmet and other safety apparel. Never drink and ride. All off-road vehicles depicted in this brochure may feature Polaris® parts and accessories and are not standard features of the base models they accompany. All performance and/or feature and benefit claims are based upon competitive data available at time of printing. For your nearest dealer, call 1-800-POLARIS or go to www.polaris.com.

Polaris Sales Inc., 2100 Hwy. 55, Medina, MN 55340 (763) 542-0500 Fax (763) 542-0599
 Polaris Industries LTD. 50 Prairie Way, Winnipeg, Manitoba, Canada R2J 3J8 (204) 925-7100 Fax (204) 925-7110



Unless noted, trademarks are the property of Polaris® Industries Inc. 509® is a registered trademark of 509, Inc. Amara® is a registered trademark of Kuraray Co. Ltd. of Japan. AP-360® is a registered trademark of TK. Bighorn® is a registered trademark of Cheng Shin Rubber USA, Inc. Bluetooth® is a registered trademark of Bluetooth Sig, Inc. ChatterBox® is a trademark of ChatterBox USA. Cordura® is a registered trademark of Invista North America S.A.R.L. Fly F2® is a registered trademark of Western Power Sports, Inc. Fly Racing® is a registered trademark of Western Power Sports, Inc. FOX® is a registered trademark of FOX Racing Shox. FXR® is a registered trademark of Factory Racewear. GE Capital® is a registered trademark of General Electric Company. iPhone® and iPod® are registered trademarks of Apple Computer, Inc. ITP® is a registered trademark of Carlisle Intangible Company. Jansen® is a registered trademark of Recoton Audio Corp. JL Audio® is a registered trademark of JL Audio, Inc. Kevlar® is a registered trademark of DuPont. Kolpin® is a registered trademark of Kolpin Outdoors, Inc. Lowrance® is a registered trademark of Navico, Inc. Lyora® is a registered trademark of INVISTA North America S.A.R.L. Maxxis® is a registered trademark of Cheng Shin Rubber Ind. Co., Ltd. Mossy Oak® is a registered trademark of Haas Outdoors, Inc. MTX® is a trademark of Mitek Corporation. PIAA® is the registered trademark of PIAA Corporation. Podium® is a registered trademark of Fox Factory, Inc. OGIO® is a registered trademark of Ogio International, Inc. SAE® is a registered trademark of Society of Automotive Engineers, Inc. Sealline® is a registered trademark of Cascade Designs, Inc. Sedona® is a trademark of Western Power Sports, Inc. Sheffield Financial® is the registered trademark of BB&T Corporation. SIXR™ is a trademark of Cheng Shin Rubber Ind. Co., Ltd. Snell® is a registered trademark of Snell Memorial Foundation, Inc. SSV Works® is a registered trademark of SSV Works, LLC. TekVest® is a registered trademark of Tekrider, Inc. Velcro® is a registered trademark of Velcro Industries B.V. Ltd Co. Netherlands. Walker Evans® is a registered trademark of Walker Evans Racing. WARN® is a registered trademark of Warn Industries, Inc. XM® is a registered trademark of Sirius XM Radio, Inc. YKK® is a registered trademark of YKK Corporation. Yoshimura® is a registered trademark of Yoshimura Research and Development of America, Inc. Prices and availability are subject to change at any moment. Copyright © 2014 Polaris® Industries. All rights reserved.

POLARIS RZR ENGINEERED PARTS, ACCESSORIES & APPAREL



ENGINEERED PARTS ACCESSORIES & APPAREL
POLARIS

2015 EVENT VERSION

POLARIS[®]

ENGINEERED PARTS
ACCESSORIES & APPAREL

MORE ATTITUDE.



MORE INTENSITY FOR A MACHINE THAT WILL TURN HEADS.

Dunes? Desert? Trails? Polaris Engineered Accessories™ offer more ways to fuel your passion and lifestyle. Because superior style isn't about conforming, it's about endless possibilities. And Polaris® offers more accessories that look right, fit right and work right so you can show off your unmatched originality with pride and confidence.

ENGINEERING NEVER STOPS.

When engineering is done well, when design is dialed-in down to the smallest detail, it's not always easy to notice. But it makes a world of difference. Lines are cleaner. Angles are tighter. The package is complete. For the Polaris Engineered™ team, fine-tuning accessories for seamless integration is what it's all about.

“The entire team is working together and integrating our processes,” says Steve Eastman, Vice President of PG&A. “We’re working further up front between the design of the vehicle and the accessories that go with that vehicle.”

From testing different UV ray exposures on various materials, beating on bumpers in the workroom, listening to riders and getting out and riding on their own time — Polaris® Engineers never stop listening and never stop refining.

“With a Polaris Engineered™ product, you know it's the world's best. They are designed specifically for our vehicles, ensuring high quality designs that meet our customers' needs,” says Dave Longren, Vice President of Off-Road Vehicles. “You know when you buy an accessory or part from us, it's the best.”

The Polaris® team knows that hard work, harder testing and endless innovating is key to making solutions that optimize any ride.

“We make the best products in power sports and that's a real tribute to the superiority of our engineering and the emphasis that we have on integration, innovation and quality,” says Eastman.



2015

RZR® PARTS, ACCESSORIES & APPAREL

TRAIL	PG 4-5
INTEGRATION STORY	PG 6-7
RZR® 900	PG 8
RZR® S 900	PG 9
DESERT	PG 10-11
DUNE	PG 12-13
CUSTOMIZATION STORY	PG 14-15
XP 1000	PG 16
XP 4 1000	PG 17
KEY COMMODITIES	PG 18-21
WINDSHIELDS	PG 22-23
ROOFS	PG 24-25
REAR PANELS	PG 26-27
DOORS	PG 28-29
STYLE	PG 30-31
BUMPERS & GUARDS	PG 32-39
WINCHES	PG 40-41
LIGHTING	PG 42-45
STORAGE & INTERIORS	PG 46-49
POLARIS® INNOVATION	PG 50-51
AUDIO	PG 52-53
COMFORT & ELECTRONICS	PG 54-59
TIRES & WHEELS	PG 60-61
PLOWS	PG 62-63
TRACKS	PG 64
YOUTH/RZR® 170	PG 65
LUBRICANTS & VEHICLE CARE	PG 66-67
MAINTENANCE PARTS	PG 68-69
TRAILERS & ACCESSORIES	PG 70-71
RAMPS & COVERS	PG 72
HERITAGE	PG 73
HELMETS	PG 74-75
GOGGLES & GLOVES	PG 76-77
OGIO® BAGS	PG 78
JERSEYS	PG 79
BASE LAYERS	PG 79
TECH WEAR	PG 79
PROTECTION	PG 80
YOUTH	PG 80
CASUAL APPAREL	PG 81-85
SIZE CHARTS	PG 85

ICON LEGEND		
	AUTO-STOP	
	FULL-COVERAGE	
	INNER LINER	
	SYNTHETIC ROPE	
	UV RESISTANT	
	DUST RESISTANT	

POLARIS[®]

ENGINEERED PARTS
ACCESSORIES & APPAREL

TRAIL



MAKE YOUR MARK. OWN THE TRAIL.

Transform your machine into the ultimate trail master. Polaris Engineered Accessories[™] supply the ultimate storage, protection and comfort options to keep your adventure going for as far as the trail leads and beyond.

POLARIS®

ENGINEERED PARTS
ACCESSORIES & APPAREL

UNLEASH YOUR PASSION

WITH POLARIS® LOCK & RIDE® ACCESSORIES,

Customizing your RZR® is as easy as deciding what you want to do and how you want to look doing it – Integration is simple and the streamlined appearance compliments your RZR®'s inspiring allure.

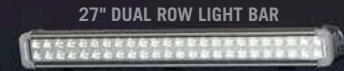

27" DUAL ROW LIGHT BAR



35" LIGHT BAR



7" LIGHT BAR



13" LIGHT BAR

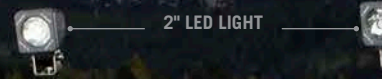

2" LED LIGHT



PREMIUM AUDIO ROOF
SEE MORE INFO ON PAGE 52

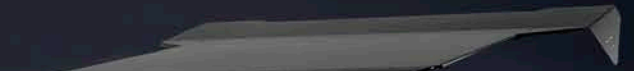

ALUMINUM ROOF



POLY SPORT ROOF



CANVAS ROOF



LOCK & RIDE® POLY WINDSHIELD



FLIP DOWN POLY WINDSHIELD



GLASS WINDSHIELD



POLY FULL WINDSHIELD

LOCK & RIDE® HALF WINDSHIELD

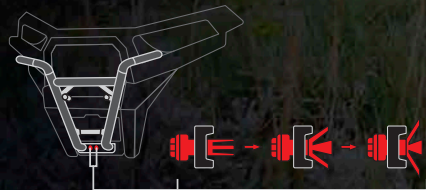

EXPANDED ANCHOR MOUNT

The Expanded Anchor Mount is tougher than conventional nuts and bolts. This hardware uses technology that allows you to change out custom accessories with no loose hardware and no damage to your frame, all in less than 5 minutes. It's also aggressively styled to perfectly match your RZR®.

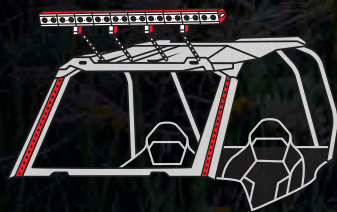

LIGHTING/AUDIO INTEGRATION

The new frame is engineered specifically for lighting and audio integration. Specific mounting points make for seamless accessory integration, hiding wiring within the cab's frame, securing your cords from damage and making for cleaner and easier install. The frame has predetermined roof-mounting locations for easy installation of accessory lighting, dash-mounted controls, overhead audio and overhead lighting.

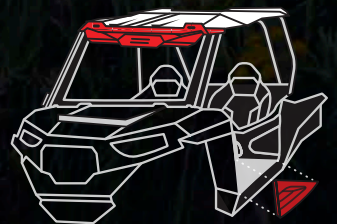

CAB COMPONENTS

Fully customize your cab. Custom doors offer pro-grade performance and protection. A lower door installs directly on a stock door in under 10 minutes, and integrated hinges and striker plates offer robust door construction and integrated sealing surfaces to help keep debris out of the cab. The integrated visor provides Lock & Ride® Sport Roof installation, with superior sealing and protection. Integrated mounting points provide simple, clean installation of all cab accessories.



HIDDEN WIRING FOR SEAMLESS INSTALL

INTEGRATED MOUNTING POINTS

CANVAS UPPER HALF DOOR

ALUMINUM HALF DOOR

LOWER DOOR INSERT

DELUXE FRONT BUMPER

LOW PROFILE STEEL ROCK SLIDERS

EXPANDED ANCHOR MOUNTS

POLARIS

ENGINEERED PARTS
ACCESSORIES & APPAREL

RIDE ON THE TRAIL'S EDGE WITH SUGGESTED PACKAGES THAT SHARPEN YOUR RZR® 900'S PERFORMANCE. INNOVATIVE POLARIS ENGINEERED ACCESSORIES™ SET THE STANDARD FOR FIT, FUNCTION AND STYLE.



RZR® 900
TRAIL PACKAGE

RZR® S 900

DESERT PACKAGE



POLARIS[®]

ENGINEERED PARTS
ACCESSORIES & APPAREL

DESERT

TEAR IT UP.

Go further and pursue rocky climbs or deep valleys with Polaris Engineered Accessories™ that safeguard your machine and elevate your style.



POLARIS[®]

ENGINEERED PARTS
ACCESSORIES & APPAREL

DUUNE

LEAD THE PACK.

Express your attitude and make an impression as you ascend peaks and soar over dunes with Polaris Engineered Accessories™.



POLARIS[®]

ENGINEERED PARTS
ACCESSORIES & APPAREL

ADD AND ENHANCE

IN THE WORLD OF *RZR*[®], CUSTOMIZATION IS KING.

So get in it to win it and customize your machine with integrated bumpers, guards, lighting and custom graphics that make your time in the dunes and desert personal. Go big.

ALUMINUM ROOFS

LOW PROFILE FRONT
BUMPERS

LOW PROFILE
REAR BUMPERS

WRAP YOUR *RZR*[®] IN STYLE

Turn heads with your *RZR*[®] suited up in a Polaris Engineered™ wraps

- Choose from complete door and body kits
- See page 28 and 31 for more details

FIERCE PROTECTION

Color-matched protection package in red, blue, white and orange

- Packages include roof, rock sliders, front and rear bumper
- See pages 32-33 for more detail

ROCK SLIDERS

POLARIS

ENGINEERED PARTS
ACCESSORIES & APPAREL

LEAVE YOUR COMPETITION IN THE DUST WITH POLARIS ENGINEERED ACCESSORIES™ DESIGNED SPECIFICALLY FOR YOUR RZR®. POLARIS® COLOR-MATCHED PROTECTION PACKAGES PROVE THAT FUNCTION AND FORM CAN COME TOGETHER TO MAXIMIZE YOUR MACHINE – POLARIS ENGINEERED ACCESSORIES™ FIT RIGHT, INSTALL SEAMLESSLY AND PERFORM EXCEPTIONALLY.



RZR® XP 4 1000

DESERT PACKAGE



RZR® XP 1000

DUNE PACKAGE

POLARIS®

ENGINEERED PARTS
ACCESSORIES & APPAREL

PULL YOUR WEIGHT.

GET YOUR JOB DONE WITH RUGGED WINCHES THAT ARE
READY TO PULL.

HEAVY-DUTY PULLING POWER FOR YOUR JOB

DESIGNED FOR POLARIS® VEHICLES

- Integrated mounting locations for a perfect fit
- One number and one price for winch, remote, contactor, mount and wiring

HIGHEST QUALITY MATERIALS

- Steel spools and cut metal gears for greater durability
- Fully-sealed contactor, motor and drive train keep water out
- Corrosion-resistant finish withstands the elements

EXTENSIVE LAB AND FIELD TESTING

- Contactors, controls and winch assemblies tested 10,000+ cycles
- Rigorous performance testing in labs and in the field ensure your winch works when you need it most
- Strength testing ensures superior driveline strength



PRO

PRO HEAVY DUTY SERIES

When world-class performance is called for, Polaris® HD PRO winches deliver. These winches combine heavy duty pulling power with premium features like auto-stop technology, synthetic rope for increased durability, aluminum hawse fairlead, and wireless remote control. Look to HD PRO winches for the best of the best.



WARN

When your ride leads to extreme conditions, look to a Polaris® WARN® winch. These workhorse winches have proven their performance and durability around the globe with an unrivaled combination of premium components built for pulling heavy loads.



HD

HEAVY DUTY SERIES

The HD line delivers industry-leading quality and durability with best-in-class value — powered by quality features including sealed motors and contactors, a roller fairlead, wired remote control and proven pulling power.

FOR MORE INFORMATION ON WINCHES, SEE PAGES 40-41.

POLARIS[®]

ENGINEERED PARTS
ACCESSORIES & APPAREL

EXTEND YOUR RIDE TIME.

ILLUMINATE THE TRAILS IN STYLE WITH POLARIS ENGINEERED™ LED LIGHT BARS FOR EVERY LIFESTYLE.



SUPERIOR TECHNOLOGY

Polaris Engineered™ offers superior performance with technology to light your way. These lights use Polaris®-exclusive LED technology, angled reflectors and a proprietary shape for full-spread light projection so you can see more — not only what's directly in front of you, but also what's in your periphery.

- Traditional LED lights cast a beam of light straight in front of you where our new Polaris®-exclusive tilted reflector technology provides a wider range of vision
- IP67 rated; fully sealed - dust tight, fully submersible for up to one meter
- Durable integrated mounting locations on Polaris® machines
- 1 year warranty
- All light bars come pre-wired
- High grade CREE LEDs

INTEGRATED 25/40 TILTED OUTER LIGHTS AND 10 DEGREE CENTER LIGHTS PROVIDE A MORE COMPLETE LIGHTING EXPERIENCE. TECHNOLOGY ONLY AVAILABLE ON THE 13" AND 35" LED LIGHT BARS.



NEW REFLECTOR TECHNOLOGY OFFERS GREAT PERIPHERAL AND FORWARD DISTANCE WITH OVER 750 FEET OF EFFECTIVE LIGHT

GREATER RANGE

See more of the trail — not only what's directly in front of you, but also what's in your periphery.

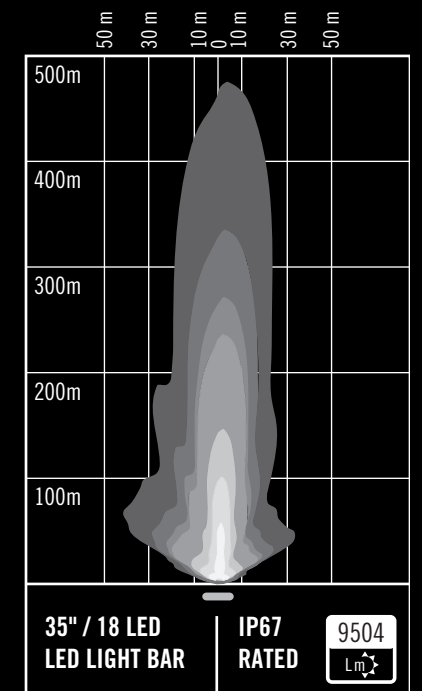
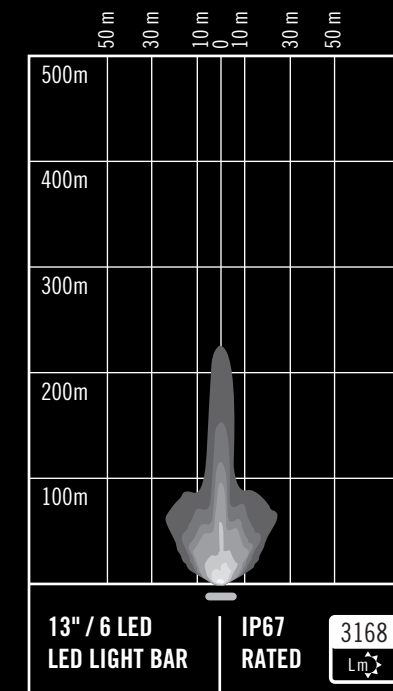
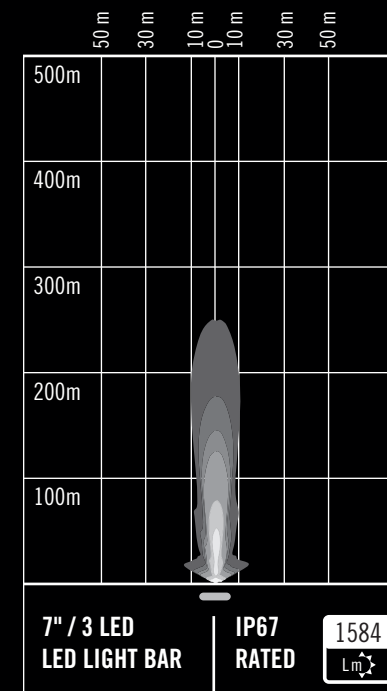

FOR OUR FULL LIGHTING LINE UP,
SEE PAGE 42

WINDSHIELDS

SEEING IS BELIEVING WITH ANY OF THE WINDSHIELDS ENGINEERED FOR YOUR RZR®. LOCK & RIDE® INNOVATION LET'S YOU SEE MORE MUD, SAND, TRAIL OR WHATEVER ELSE IS AHEAD OF YOU.



GLASS WINDSHIELD

- Laminate safety glass for excellent scratch resistance
- Installs in minutes and integrates into a designated mounting position
- Windshield surface seals directly to the visor with no additional framework needed
- Increased visibility with a reduction of framework
- Offers maximum protection and durability from wind, rain and off-road hazards

2879447

RZR® XP 1000 MY 14-15, RZR® XP 4 1000 MY 14-15, RZR® 900 MY 15, RZR® S 900 MY 15, RZR® 900 XC MY 15
This windshield works with accessory Windshield Wiper Kit 2879526, see page 57



FLIP-DOWN POLY WINDSHIELD **NEW**

- Versatile, adjustable windshield lets riders customize airflow and protection
- Windshield can be closed (up position) for full coverage, opened slightly for airflow, or laid flat on hood (wide open)
- Enhances rider comfort, protection and visibility in all riding conditions
- Windshield position can be adjusted easily as riding conditions change
- Material is .236" polycarbonate construction with hard coat on both sides that is impact, shatter and scratch resistant.
- Mounts easily into vehicle frame in designated mounting locations

2879505

RZR® XP 1000 MY 14-15, RZR® XP 4 1000 MY 14-15, RZR® 900 MY 15, RZR® S 900 MY 15, RZR® 900 XC MY 15



LOCK & RIDE

LOCK & RIDE® POLY FULL WINDSHIELD **NEW**

- Full-size windshield installs easily and provides riders with full front protection
- Ensures rider enjoys comfort and great visibility in all riding conditions
- .177 polycarbonate construction with hard coat on both sides that is impact, shatter and scratch resistant
- Mounts easily into vehicle frame in designated mounting locations using Lock & Ride® technology — no tools required

2880501

RZR® XP 1000 MY 14-15, RZR® XP 4 1000 MY 14-15, RZR® 900 MY 15, RZR® S 900 MY 15, RZR® 900 XC MY 15



LOCK & RIDE

LOCK & RIDE® WINDSHIELD

- Lock & Ride®: Installs quickly and easily without tools
- Durable, optical-grade polycarbonate for maximum impact resistance, with no frame for maximum visibility
- Seals fully on cab frame and hood for optimized protection
- Integrates with all cab components

2879492

RZR® 570 MY 12-15, RZR® 800 MY 08-14, RZR® S MY 09-14, RZR® 4 MY 10-14, RZR® 900 MY 11-14, RZR® 900 4 MY 11-14



POLY FULL WINDSHIELD

- Durable, optical-grade polycarbonate for maximum impact resistance
- Installs in minutes without tools and integrates into a designated mounting position
- Includes mounting hardware

2879446

RZR® XP 1000 MY 14-15, RZR® XP 4 1000 MY 14-15, RZR® 900 MY 15, RZR® S 900 MY 15, RZR® 900 XC MY 15



LOCK & RIDE

LOCK & RIDE® HALF WINDSHIELD

- Strong, durable, impact-resistant polycarbonate
- Half Windshield installs in minutes without tools using Lock & Ride® technology and integrates into a designated mounting position
- Ideal for high heat/dust conditions
- Unique shape directs airflow and dust away from occupants
- Includes mounting hardware

2879504

RZR® XP 1000 MY 14-15, RZR® XP 4 1000 MY 14-15, RZR® 900 MY 15, RZR® S 900 MY 15, RZR® 900 XC MY 15



LOCK & RIDE

LOCK & RIDE® HALF WINDSHIELD

- Provides protection and delivers optimum airflow into the cab
- Ideal for high heat/dust conditions
- Strong, durable, impact-resistant polycarbonate
- Unique shape directs airflow and dust away from occupants
- Lock & Ride®: Installs quickly and easily without tools
- Fully-sealed lower section of windshield to hood

2879493

RZR® 570 MY 12-15, RZR® 800 MY 08-14, RZR® S MY 09-14, RZR® 4 MY 10-14, RZR® 900 MY 11-14, RZR® 900 4 MY 11-14

ROOFS

MORE ROOF CHOICES FOR YOUR RIDE. WHETHER IT'S FOR PROTECTION, STYLE OR SHADE, THERE'S A ROOF THAT WILL SEAMLESSLY FIT AND FUNCTION WITH YOUR RZR®.



AVAILABLE OCTOBER 2014
Visit page 53 for even more information on MTX audio options.

PREMIUM AUDIO ROOF **NEW**

- The most versatile single accessory ever offered, providing protection, comfort, style, storage, lighting, and premium audio
- Strong, durable black molded-poly roof provides shade and reliable overhead protection
- Roof is styled to complement the sporty look of the RZR®
- Roof mounts easily on the vehicle frame in designated locations using provided hardware
- Audio system is completely integrated under the roof
- Audio head unit positioned at front of roof with controls within reach of driver and passenger
- Audio is delivered through four powerful 6x9 speakers
- Accessory subwoofer (2880502; sold separately) can be mounted under the dash for enhanced output
- Multi-angle LED Light Bars are integrated in recesses at the front and rear of the roof
- Front of roof houses three light bars
- Rear of roof has taillights and powerful LED floodlight
- Under-roof storage pod is foam padded to safely secure small items

2880417

RZR® XP 1000 MY 14-15, RZR® 900 MY 15, RZR® S 900 MY 15, RZR® 900 XC MY 15



ALUMINUM ROOF

- Stylish and functional, this roof provides color-coordinated style, shade and outstanding overhead protection
- This roof seals to the vehicle frame for the best protection and great integration with other RZR® accessories
- Durable powder-coat finish coordinates with the vehicle's bodywork and matching accessories
- Strong and durable 5051 aluminum construction for long-lasting reliable protection
- Roof can be used with RZR® accessories such as windshields, rear panels, doors, audio systems, auxiliary lighting and more (each sold separately)

2879443-458 | Black

2879443-133 | White

2879443-293 **NEW** | Red

2879443-619 **NEW** | Blue

2879443-589 | Orange

RZR® XP 1000 MY 14-15, RZR® 900 MY 15, RZR® S 900 MY 15, RZR® 900 XC MY 15

Refer to pages 32-33 for color package options.



RZR® XP 4 1000 ALUMINUM ROOF

- Stylish and functional, this roof provides color-coordinated style, shade and outstanding overhead protection
- This roof seals to the vehicle frame for the best protection and great integration with other RZR® accessories
- Roof consists of two panels that seal together for full, no-leak protection
- Durable powder-coat finish coordinates with the vehicle's bodywork and matching accessories
- Strong and durable 5051 aluminum construction for long-lasting reliable protection
- Roof can be used with RZR® accessories such as windshields, rear panels, doors, audio systems, auxiliary lighting and more (each sold separately)

2879939-458 | Black

2879939-133 | White

2879939-293 **NEW** | Red

2879939-619 **NEW** | Blue

2879939-589 | Orange

RZR® XP 4 1000 MY 14-15

Refer to pages 32-33 for color package options.



LOCK & RIDE

LOCK & RIDE® POLY SPORT ROOF

- Rigid injection-molded design to eliminate warping in high-heat conditions
- Integrated mounting locations for lighting
- Lock & Ride®: Installs quickly and easily without tools

2879442 | Black

RZR® XP 1000 MY 14-15, RZR® 900 MY 15, RZR® S 900 MY 15, RZR® 900 XC MY 15



LOCK & RIDE

RZR XP 4 LOCK & RIDE® POLY SPORT ROOF **NEW**

- Lock & Ride®: Installs quickly and easily without tools
- Rigid injection-molded design to eliminate warping in high-heat conditions
- Integrated mounting locations for lighting

2879937

RZR® XP 4 1000 MY 14-15



CANVAS ROOF

- Durable, heavyweight 23-oz. polyester canvas construction
- Canvas is mold-resistant and UV-stable to resist fading and deliver long-lasting performance
- Installs quickly and easily with provided straps

2879900 | Black

RZR® XP 1000 MY 14-15

2880561 **NEW**

RZR® 900 MY 15, RZR® S 900 MY 15, RZR® 900 XC MY 15



RZR XP 4 CANVAS ROOF **NEW**

- Durable, heavyweight 23-oz. polyester canvas construction
- Canvas is mold-resistant and UV-stable to resist fading and deliver long-lasting performance
- Installs quickly and easily with provided straps

2879944

RZR® XP 4 1000 MY 14-15



LOCK & RIDE

LOCK & RIDE® SPORT ROOF

- Lock & Ride®: Installs quickly and easily without tools
- Rigid injection-molded design to eliminate warping in high-heat conditions
- Rugged textured polyethylene construction for impact and abrasion resistance
- Integrated LED mounting locations
- Aggressive styling to match the RZR® design

2878748

RZR® 570 MY 12-15, RZR® 800 MY 08-14, RZR® S MY 09-14, RZR® 900 MY 11-15



LOCK & RIDE

LOCK & RIDE® POLY ROOF

- Lock & Ride®: Installs quickly and easily without tools
- Made of rugged, scratch-resistant, high-density polyethylene
- 2-panel design with seal preventers leaking
- Sporty styling complements RZR® design
- Roof design promotes efficient rain drainage

2878903

RZR® 4 MY 10-14, RZR® 900 4 MY 12-14

REAR PANELS

MAKE IT YOURS FROM FRONT TO BACK. FOUR UNIQUE REAR PANEL MATERIALS LET YOU MAKE MORE OF YOUR RIDE FOR THE PERFECT MIX OF STYLE AND AIRFLOW.



CANVAS REAR PANEL **NEW**

- Provides reliable protection and enhanced comfort, at a price point that delivers outstanding value
- The 23-oz. polyester canvas is mold-resistant for long-term performance and UV-stable to resist fading from prolonged exposure to sunlight
- The large vinyl window provides excellent rearward visibility while letting light into the cab
- This rear panel installs in minutes in designated mounting positions on the vehicle frame
- Requires minimal tools for installation
- Can be used along with additional RZR® accessories such as windshields, roofs, doors, audio systems, mirrors, auxiliary lights and more (each sold separately)

2880608

RZR® 900 MY 15, RZR® S 900 MY 15, RZR® 900 XC MY 15



LOCK & RIDE® POLY REAR PANEL **NEW**

- Provides outstanding combination of protection, rearward visibility, and dust-blocking when the RZR® is equipped with a windshield (sold separately)
- Rear panel installs quickly and easily — no tools required — using Polaris®-exclusive Lock & Ride® technology
- Provides protection from inclement weather and off-road hazards
- Can be used along with RZR® accessories such as windshields, roofs, doors, audio systems, mirrors, auxiliary lights and more (each sold separately)

2880167

RZR® 900 MY 15, RZR® S 900 MY 15, RZR® 900 XC MY 15



MESH REAR PANEL **NEW**

- Mesh Rear Panel gives RZR® riders a stylish race look as well as rearward visibility and airflow
- Heavy-duty mesh fabric provides modest shade and protection from inclement weather
- Rear panel installs quickly and easily to vehicle frame using provided straps
- When not needed, the rear panel can be removed and stored in the vehicle
- Stylish rear panel features Polaris® branding and is similar to rear panel used by Polaris® RZR® racers
- Rear panel can be used with RZR® accessories such as windshields, roofs, doors, audio systems, mirrors, auxiliary lighting and more (each sold separately)

2880409

RZR® 900 MY 15, RZR® S 900 MY 15, RZR® 900 XC MY 15



REAR RACE NET **NEW**

- Ultra-strong and durable fabric net construction
- Net construction provides rearward visibility and airflow
- Easy to install: It attaches to the vehicle framework using provided mounting hardware
- Easy to store: Rear panel can be rolled or folded and stored in the vehicle when not needed
- Custom reflective RZR® graphic for increased night time visibility

2880408

RZR® 900 MY 15, RZR® S 900 MY 15, RZR® 900 XC MY 15



LOCK & RIDE® POLY REAR PANEL

- Lock & Ride®: Installs quickly and easily without tools
- Durable, impact-resistant polycarbonate
- Recommended to reduce dust swirl in cab

2879448

RZR® XP 1000 MY 14-15, RZR® XP 4 1000 MY 14-15



REAR RACE NET

- Provides protection from your cargo while providing maximum airflow through the cab
- Off-road racing inspired styling
- Quick buckle installation and removal
- Custom reflective RZR® graphic for increased night time visibility

2879936

RZR® XP 1000 MY 14-15, RZR® XP 4 1000 MY 14-15



MESH REAR PANEL

- Rear panel installs in minutes using provided Velcro® fasteners in designated mounting positions on the RZR® XP 1000 frame
- Tight mesh fabric allows for airflow through the cab while blocking out debris and sunlight

2879507

RZR® XP 1000 MY 14-15, RZR® XP 4 1000 MY 14-15



CANVAS REAR PANEL

- Material: 23-oz. polyester canvas and vinyl window
- Rear panel installs in minutes with no tools in designated mounting positions on the RZR® XP 1000 frame
- High-quality, durable polyester for UV protection and mildew resistance
- Rugged vinyl window that is UV and cold crack resistant
- Includes Canvas Rear Panel and mounting hardware

2879901

RZR® XP 1000 MY 14-15, RZR® XP 4 1000 MY 14-15



REAR RACE NET

- Provides protection from your cargo while providing maximum airflow through the cab
- Cool, off-road racing-inspired styling
- Recommended for use with half or dual windshield (sold separately)

2877577

RZR® 570 MY 12-15, RZR® 800 MY 08-14, RZR® S MY 09-14, RZR® 900 MY 11-14



LOCK & RIDE® REAR PANEL

- Lock & Ride®: Installs quickly and easily without tools
- Durable, impact-resistant polycarbonate
- Recommended to reduce dust swirl in cab

2878752

RZR® 570 MY 12-15, RZR® 800 MY 08-14, RZR® S MY 09-14, RZR® 900 MY 11-14

2878753

RZR® 4 MY 10-14

DOORS



LOWER DOOR INSERTS

- Durable plastic construction with steel frame
- Highly integrated and installs in minutes, bolting to existing door utilizing stock hardware
- Gasket designed to eliminate rattles and supply added sealing
- Styled to match the your RZR's design lines so they fit in seamlessly
- Protection from the elements keeps mud and dust out from the inside of the vehicle

- A. 2879509**
RZR® XP 1000 MY 14-15, RZR® S 900 MY 15, RZR® XC MY 15
- B. 2880207** **NEW**
RZR® 900 MY 15
- C. 2879942**
RZR® XP 4 1000 MY 14-15

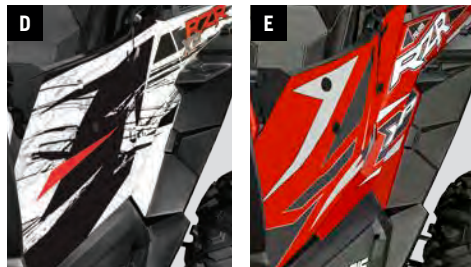

RZR® XP 1000 ALUMINUM DOOR GRAPHICS **NEW**

- These door graphics are a continuation of the stock graphics

- D. 2880498** | White Lightning RZR® XP 1000 MY 14
- E. 2880872** | Havasu Red Pearl
RZR® XP 1000 MY 15
- F. 2880873** | Voodoo Blue
RZR® XP 1000 MY 15
- G. 2880499** | Orange Titanium RZR® XP 1000 MY 14
- H. 2880874** | White Lightning II
RZR® XP 1000 MY 15

Requires Aluminum Doors (2879510; sold separately)



ALUMINUM DOORS **NEW**

- Race-inspired, strong, durable, aluminum construction ensures reliable protection, a great fit and enhanced style
- Highly integrated and installs in minutes; replaces existing door plastics and utilizes stock hardware
- Gives vehicle finished, full-custom look and also increases rider protection
- Latches and hinges feature strong, durable, reliable steel construction, and gasket design eliminates rattling
- Can be equipped with accessory graphic wraps (sold separately)

2879510
RZR® XP 1000 MY 14-15, RZR® 900 MY 15*, RZR® S 900 MY 15, RZR® 900 XC MY 15
* Will only fit if Wide Door Kit (2880328) is installed

2879943
RZR® XP 4 1000 MY 14-15

CANVAS UPPER HALF DOORS

- High-quality, durable polyester for UV protection and mildew resistance
- Rugged vinyl window that is UV and cold-crack resistant
- Requires purchase of lower half doors (2879509; sold separately) for complete full doors
- The canvas door perimeter is mounted on a sturdy steel tubular frame that ensures the upper door holds its shape

2879902 | Black
RZR® XP 1000 MY 14-15, RZR® S 900 MY 15, RZR® 900 XC MY 15
2879946
RZR® XP 4 1000 MY 14-15

2880609 **NEW**
RZR® 900 MY 15
Only recommended for use with Polaris® full windshield and lower poly doors
2880609 recommended to be used with canvas rear panel (2880608)

WIDE DOOR KIT **NEW**

- Doors' exterior contours extend outward, creating overall vehicle width of approximately 54"
- Door contour enhances rider comfort by providing additional lateral space for riders' knees and elbows
- Doors install easily on steel framework of stock doors

2880328
RZR® 900 MY 15
Works with 2879509 Poly Doors

RZR® BLACK POWDER-COAT FINISH DOORS

- Industry-leading ease of installation — no cutting, welding or drilling required
- Race-inspired lightweight aluminum construction
- Rubber-mounted vibration dampeners eliminate rattling
- Steel frame, hinges and latches for rugged off-road durability
- Color-coordinated custom graphics available to add style and complement the look of your RZR® (sold separately)

2879614 | Black
RZR® 570, RZR® 800, RZR® S, RZR® 900



CHECK OUT ALL NEW DOOR LINERS AND DOOR STORAGE BAGS ON PAGE 48

STYLE

STYLE AND CONFIDENCE GO HAND-IN-HAND. WHEN YOU LOOK GOOD, YOU FEEL GOOD AND WHEN YOU FEEL GOOD, YOU'LL GIVE IT MORE GO. ADD COLOR-MATCHED PARTS AND ATTENTION-GRABBING GRAPHICS ENGINEERED BY POLARIS®, AND LET YOUR RIDE RIP.







RZR® GRAPHICS WRAP KITS





- Durable, premium-quality vinyl graphics that wrap the entire vehicle including hood, side panels and doors (sold separately)
- Graphics have adhesive backing for secure, durable installation
- Graphics are custom-cut for a premium fit on your RZR XP or RZR S 900
- Aluminum Half Doors (2879510) or Lower Poly Doors (2879509) required for installation (sold separately)
- Bold graphics with multi-colored accents and Polaris® branding that coordinate with bodywork and accessories
- Graphics give the RZR® a complete, integrated, custom look



DRAGON NEW

COLOR	ALUMINUM DOORS	POLY DOORS
	2880839 RZR® S 900	2880840 RZR® S 900
	2880847 RZR® XP 1000	2880848 RZR® XP 1000
	2880841 RZR® S 900	2880842 RZR® S 900
	2880849 RZR® XP 1000	2880850 RZR® XP 1000

RACE NEW

COLOR	ALUMINUM DOORS	POLY DOORS
	2880843 RZR® S 900	2880844 RZR® S 900
	2880851 RZR® XP 1000	2880852 RZR® XP 1000
	2880845 RZR® S 900	2880846 RZR® S 900
	2880853 RZR® XP 1000	2880854 RZR® XP 1000

POLARIS®

ENGINEERED PARTS
ACCESSORIES & APPAREL

BUMPERS & GUARDS

RZR® RIDERS KNOW HOW TO GO BIG. ADD A BUMPER OR BRUSHGUARD SO YOU CAN GO EVEN BIGGER. POLARIS® INNOVATION HAS LED TO A STRONGER BUILD, ENGINEERED TO FIT FLAWLESSLY ON YOUR RIDE.



PROTECTION PACKAGES

- Install a full complement of colored accessories for coordinated custom style and outstanding vehicle protection
- Strong, durable construction of the bumpers and rock sliders provide protection of the vehicle's front, rear and sides
- Low Profile Rock Sliders provide side protection without compromising ground clearance
- Front and Rear Bumpers deliver outstanding protection, without blocking light
- Strong aluminum roof provides riders with shade and overhead protection from off-road hazards and inclement weather
- Purchasing the package delivers outstanding value compared to purchasing accessories individually
- Easy bolt-on installation of all accessories
- All included accessories can be used along with accessories such as a winch, plow system, auxiliary lighting, implements and more (each sold separately)
- Additional color-coordinated accessories available including Beadlock Rings (sold separately) for the wheels

RZR® 900 COLOR PROTECTION PACKAGE **NEW**

- Front Bumper
- Rear Bumper
- Aluminum Roof
- Low Profile Rock Sliders

2859450 | White RZR® 900, RZR® S 900 MY 15, RZR® 900 XC MY 15

2859451 | Red RZR® 900 MY 15, RZR® S 900 MY 15, RZR® 900 XC MY 15



RZR® XP 1000 LOW PROFILE PACKAGE

- Front Bumper
- Rear Bumper
- Aluminum Roof
- Low Profile Rock Sliders

2850105 | White

RZR® XP 1000 MY 14-15

2859444 **NEW** | Blue

RZR® XP 1000 MY 14-15

2859445 **NEW** | Red

RZR® XP 1000 MY 14-15

2850102 | Orange (Not Shown)

RZR® XP 1000 MY 14-15



RZR® XP 4 1000 LOW PROFILE PACKAGE

- Front Bumper
- Rear Bumper
- Aluminum Roof
- Low Profile Rock Sliders

2859902 | White

RZR® XP 4 1000 MY 14-15

2859446 **NEW** | Blue

RZR® XP 4 1000 MY 14-15

2859447 **NEW** | Red

RZR® XP 4 1000 MY 14-15

2859901 | Orange (Not Shown)

RZR® XP 4 1000 MY 14-15

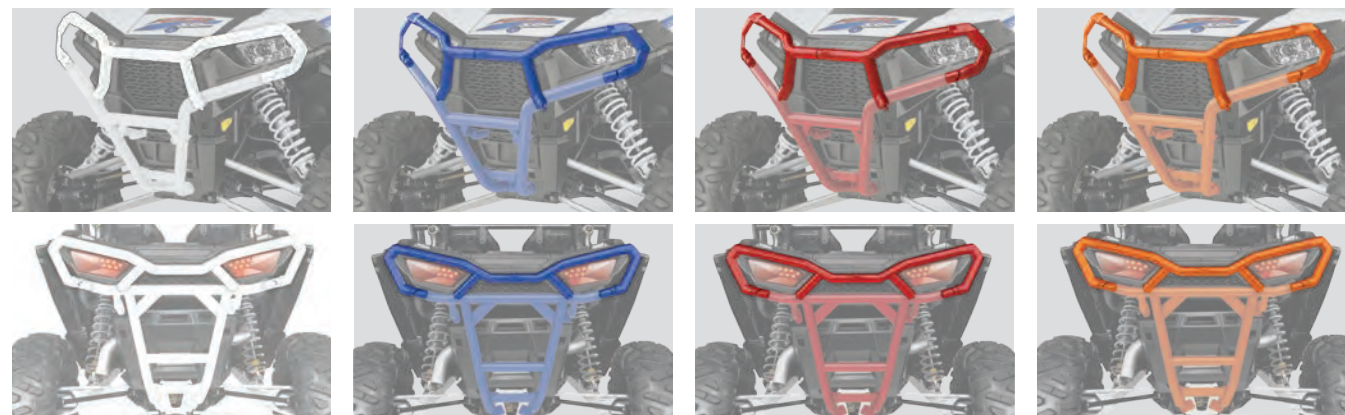

WHITE EXTREME ATTACHMENT PACKAGE

- White Extreme Front Attachment
- White Extreme Rear Attachment

2850106

RZR® XP 1000 MY 14-15, RZR® XP 4 1000 MY 14-15



BLUE EXTREME ATTACHMENT PACKAGE **NEW**

- Blue Extreme Front Attachment
- Blue Extreme Rear Attachment

2859448

RZR® XP 1000 MY 14-15, RZR® XP 4 1000 MY 14-15



RED EXTREME ATTACHMENT PACKAGE **NEW**

- Red Extreme Front Attachment
- Red Extreme Rear Attachment

2859449

RZR® XP 1000 MY 14-15, RZR® XP 4 1000 MY 14-15



ORANGE EXTREME ATTACHMENT PACKAGE

- Red Extreme Front Attachment
- Red Extreme Rear Attachment

2850103

RZR® XP 1000 MY 14-15, RZR® XP 4 1000 MY 14-15



BUMPERS & GUARDS



DELUXE FRONT BUMPERS **NEW**

- Ideal for trail riding; strong, durable protection for front-end components, including headlights
- 1.5" diameter steel tube construction
- Durable powder-coat finish that complements the look of the vehicle's framework
- Installs easily using Expanding Anchor technology in pre-drilled mounting locations on the vehicle
- Can be used in conjunction with accessories such as a winch, plow system, auxiliary lighting, etc.

2880166-458 | Black

2880166-293 | Red

2880166-133 | White

RZR® 900 MY 15, RZR® S 900 MY 15, RZR® 900 XC MY 15, RZR® XP 1000 MY 14-15, RZR® XP 4 1000 MY 14-15



DELUXE REAR BUMPERS **NEW**

- Strong, reliable protection for rear-end components, including taillights
- 1.5" diameter steel tube construction
- Durable powder-coat finish that complements the look of the vehicle's framework
- Installs easily using Expanding Anchor technology in pre-drilled mounting locations on the vehicle
- Can be used in conjunction with accessories such as a winch, tow hitch, implements, auxiliary lighting, etc.

2880164-458 | Black

2880164-293 | Red

2880164-133 | White

RZR® 900 MY 15, RZR® S 900 MY 15, RZR® 900 XC MY 15



BUMPER ADAPTER **NEW**

- Bumper Adapter connects Upper Cab Frame Extension with rear bumper (each sold separately, 2880411 and 2880164-458)
- Strong and durable cast steel construction
- Adapters bolt into place quickly and easily in designated mounting points

2880165



UPPER REAR CAB FRAME EXTENSIONS **NEW**

- Strong, durable, cast steel construction
- Provides enhanced protection for the rear of the vehicle and multiple accessory mounting opportunities
- Offers numerous versatile tie-down and connection points for bungees, straps, cargo nets, etc.
- Premium black powder-coat finish coordinates with vehicle's framework
- Gives the vehicle race-inspired style
- Installs easily in designated mounting location on vehicle's frame
- Attaches directly to the Lower Rear Cab Frame Extension (sold separately, 2880412) or Bumper Adapter (sold separately, 2880165) to connect with applicable rear brushguard

2880411

RZR® 900 MY 15, RZR® S 900 MY 15, RZR® 900 XC MY 15

LOWER REAR CAB FRAME EXTENSIONS **NEW**

- Strong, durable, cast steel construction
- Provides enhanced protection for the rear of the vehicle and multiple accessory mounting opportunities
- Offers numerous versatile tie-down and connection points for bungees, straps, cargo nets, etc.
- Premium black powder-coat finish coordinates with vehicle's framework
- Gives the vehicle race-inspired style
- Installs easily in designated mounting location on vehicle's chassis

2880412

RZR® 900 MY 15, RZR® S 900 MY 15, RZR® 900 XC MY 15

Requires the Upper Rear Cab Frame Extension (sold separately, 2880411)



BUMPERS & GUARDS



LOW PROFILE FRONT BUMPER

- Material: 1 3/4" diameter steel tube
- Installation into designated mounting points
- Durable powder-coated finish
- Integrated light mounting
- Uses expanded anchor technology for install
- Low profile design provides protection for the front of the vehicle

2879449-619 **NEW** | Blue

2879449-293 **NEW** | Red

2879449-589 | Orange (Not Shown)

2879449-458 | Black

2879449-133 | White

RZR® XP 1000 MY 14-15, RZR® XP 4 1000 MY 14-15, RZR® 900 MY 15, RZR® S 900 MY 15, RZR® 900 XC MY 15



LOW PROFILE REAR BUMPER

- Material: 1 3/4" diameter steel tube
- Quick installation into designated mounting points
- Durable powder-coated finish
- Integrated light mounting
- Uses expanded anchor technology for install
- Low profile design provides protection for the rear of the vehicle

2880560-619 **NEW** | Blue

2880560-293 **NEW** | Red

2879450-589 | Orange (Not Shown)

2879450-458 | Black

2880560-133 | White

RZR® XP 1000 MY 14-15, RZR® XP 4 1000 MY 14-15

28779450 does not fit with high clearance rear radius rods, 2879523-458

EXTREME ATTACHMENT FRONT BUMPER

- Cast steel corners for headlight and taillight protection and style
- Durable powder coat finish
- 1 3/4" thick steel tube
- Installs onto Low Profile Bumper
- Durable matte black powder-coated finish
- Integrated light mounting
- Uses expanded anchor technology for install

2879451-619 **NEW** | Blue

2879451-293 **NEW** | Red

2879451-589 | Orange (Not Shown)

2879451-458 | Black

2879451-133 | White

RZR® XP 1000 MY 14-15, RZR® XP 4 1000 MY 14-15, RZR® 900 MY 15, RZR® S 900 MY 15, RZR® 900 XC MY 15

Requires Low Profile Front Bumper 2879449-458

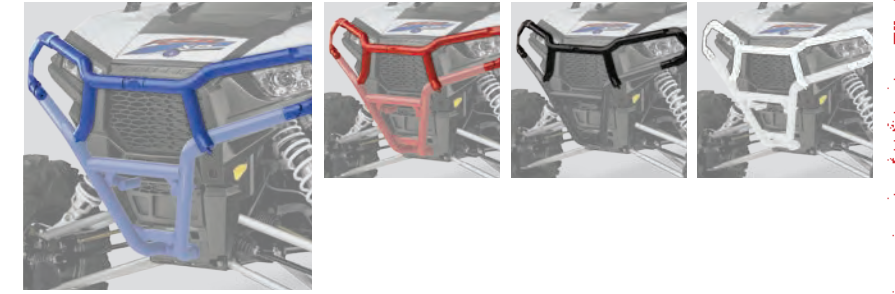

EXTREME ATTACHMENT REAR BUMPER

2879452-619 **NEW** | Blue

2879452-293 **NEW** | Red

2879452-589 | Orange (Not Shown)

2879452-458 | Black

2879452-133 | White

RZR® XP 1000 MY 14-15, RZR® XP 4 1000 MY 14-15

Requires Low Profile Rear Bumper 2879450-458

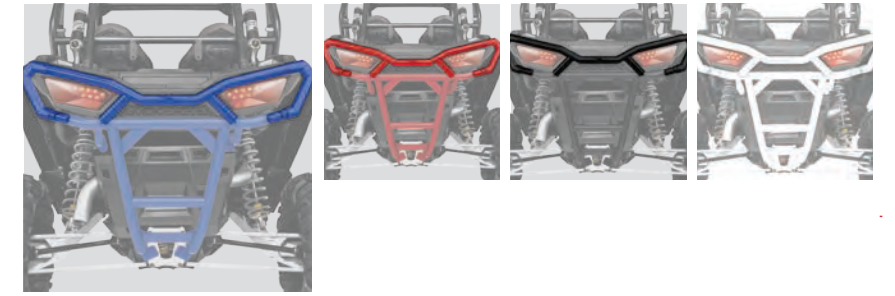

PRE-RUNNER BRUSHGUARD

- Provides protection for the front and rear of the vehicle
- High-performance design complements the vehicle's sporty styling
- Strong 1.5" (3.8 cm) diameter steel tube construction with a black powder-coat finish
- Installs easily in pre-drilled mounting locations
- Integrates with any winch or plow system
- Light mounting tabs on front
- Ideal for trail riding; protects against unseen hazards

2878282 | Front

RZR® 570 MY 11-15, RZR® 800 MY 08-14, RZR® 4 MY 10-14, RZR® 900 MY 11-14, RZR® 900 4 MY 12-14

2878279 | Rear

RZR® 900 MY 11-14, RZR® 900 4 MY 12-14



DELUXE BRUSHGUARD

- Ideal for trail riding
- Provides maximum headlight and taillight protection
- High-performance design complements the vehicle's sporty styling
- Strong 1.25" (3.2 cm) diameter steel tube construction with a black powder-coat finish
- Installs easily in pre-drilled mounting locations
- Integrates with any winch or plow system
- Light mounting tabs on front

2878284 | Front

RZR® 570 MY 11-15, RZR® 800 MY 08-14, RZR® 4 MY 10-14, RZR® 900 MY 11-14, RZR® 900 4 MY 12-14

2878285 | Rear

RZR® 800 MY 08-14, RZR® S MY 09-14, RZR® 4 MY 10-14

2878697 | Rear

RZR® 570 MY 12-14



BUMPERS & GUARDS

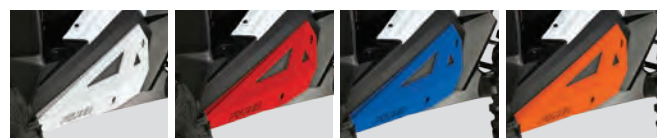

LOW PROFILE STEEL ROCK SLIDERS

- Plate steel construction, durable powder-coat finish
- Easy installation with expanded anchor mount
- No loss in ground clearance while protecting lower body panels

2879498-458 | Black

2879498-133 | White

2879498-619 **NEW** | Blue

2879498-293 **NEW** | Red

2879498-589 | Orange

RZR® XP 1000 MY 14-15, RZR® 900 MY 15, RZR® S 900 MY 15, RZR® 900 XC MY 15

Refer to pages 32 and 33 for white, red, blue and orange package options.



RZR XP 4 LOW PROFILE STEEL ROCK SLIDERS

- Easy installation with expanded anchor mount
- No loss in ground clearance while protecting lower body panels
- Plate steel construction, durable powder-coat finish

2879940-458 | Black

2879940-133 | White

2879940-619 **NEW** | Blue

2879940-293 **NEW** | Red

2879940-589 | Orange

RZR® XP 4 1000 MY 14-15



EXTREME KICK-OUT STEEL ROCK SLIDERS

- 1¾"-thick steel tube construction
- Matte black powder-coat finish
- 5" kick-out protects side of vehicle from obstacles and provides a buffer between vehicle and trail obstacles
- Quick and easy install with expanded anchor mounting system

2879456-458 | Black

RZR® XP 1000 MY 14-15, RZR® 900 MY 15, RZR® S 900 MY 15, RZR® 900 XC MY 15



STEEL ROCK SLIDERS

- Smart styling complements the sporty look of the vehicle
- Protects the sides and bottom of the vehicle from rocks, stumps and other off-road hazards
- Durable tube construction with a rust-resistant powder-coat finish
- Easy installation with pre-drilled mounting locations
- Excellent protection from rocks and stumps, ideal for trails
- Max ground clearance and max protection

2878286

RZR® 570 MY 12-15, RZR® 800 MY 08-14, RZR® S MY 09-14



FENDER FLARE KIT **NEW**

- Enjoy extended coverage over your wide tires or widened suspension
- Fender Flares block mud and debris kicked up by the tires while riding
- Integrated styling makes these over-fenders look like stock bodywork

2879434

RZR® 900 MY 15



MUDFLAPS **NEW**

- Rigid injection-molded design to eliminate warping in high-heat conditions
- Designed to specifically integrate into front fender flares
- Keeps the front wheels from flipping mud into the cab

2879938

RZR® XP 1000 MY 14-15, RZR® XP 4 1000 MY 14-15, RZR® S 900 MY 15, RZR® 900 XC MY 15



INTRUSION BAR **NEW**

- Lightweight, durable welded steel construction
- Bolts quickly, easily and securely to existing frame
- Provides race-inspired styling to your machine
- Can be used with other accessories such as audio systems and auxiliary lighting

2879181

RZR® XP 1000 MY 14-15, RZR® XP 4 1000 MY 14-15, RZR® 900 MY 15, RZR® S 900 MY 15, RZR® 900 XC MY 15

Will not work with any full windshield



REAR A-ARM GUARDS **NEW**

- Valuable, reliable protection for vital rear suspension components of your machine
- Strong, durable, lightweight HMW (high-molecular weight) polyethylene construction withstands off-road impacts to protect the A-Arms
- Molded specifically for the RZR® rear suspension for proper installation, a sure fit and low-profile presence

2880171 | Black

RZR® S 900 MY 15

2880172 | Black

RZR® 900 MY 15, RZR® 900 XC MY 15

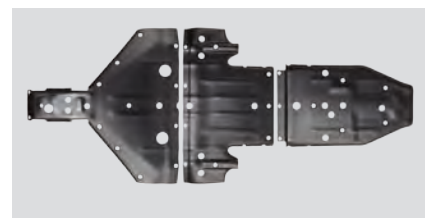

HMW SKID PLATE

- Valuable, reliable protection for the undercarriage of your machine
- Strong, durable, lightweight HMW (high-molecular weight) polyethylene construction withstands off-road impacts to protect the vehicle's underside
- This ¾" HMW skid plate complements the protection provided by the stock skid plate
- Molded specifically for these RZR® models' undercarriage for proper installation, a sure fit and low-profile presence

2879455 | Black

RZR® XP 1000 MY 14-15

2880290 **NEW** | Black

RZR® 900 MY 15, RZR® S 900 MY 15, RZR® 900 XC MY 15

2879948 **NEW** | Black

RZR® XP 4 1000 MY 14-15

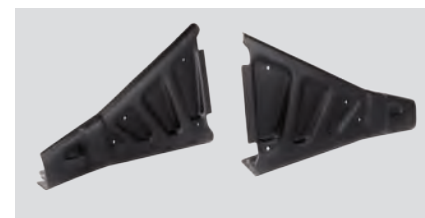

HMW FRONT A-ARM GUARDS

- Valuable, reliable protection for vital front suspension components of your machine
- Strong, durable, lightweight HMW (high-molecular weight) polyethylene construction withstands off-road impacts to protect the A-Arms
- Molded specifically for the RZR® front suspension for proper installation, a sure fit and low-profile presence

2879454 | Black

RZR® XP 1000 MY 14-15

2880274 **NEW** | Black

RZR® S 900 MY 15

2880170 **NEW** | Black

RZR® 900 MY 15, RZR® 900 XC MY 15



HMW REAR TRAILING ARM GUARDS

- Valuable, reliable protection for vital rear suspension components of your machine
- Strong, durable, lightweight HMW (high-molecular weight) polyethylene construction withstands off-road impacts to protect the Trailing Arms
- Molded specifically for the RZR® rear suspension for proper installation, a sure fit and low-profile presence

2879496 | Black

RZR® XP 1000 MY 14-15, RZR® XP 4 1000 MY 14-15

POLARIS®

ENGINEERED PARTS
ACCESSORIES & APPAREL

WINCHES

PRO PRO HEAVY DUTY SERIES

PREMIUM FEATURES FOR HEAVY-DUTY PULLING POWER

AUTO-STOP TECHNOLOGY

- Stops winch at end of pull, prevents driveline stress
- Great for plowing, prevents overlifting
- Winch stops when collar on rope contacts fairlead

ALUMINUM FAIRLEAD

- Improves rope life, corrosion resistant

SYNTHETIC ROPE

- Superior flexibility, great strength, lightweight

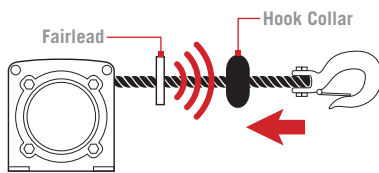

Winch stops when fairlead detects hook collar.

HD HEAVY DUTY SERIES

HEAVY-DUTY PULLING POWER

- Cut steel gears for improved durability
- Steel spool can handle extreme loads
- 40% quieter — near-silent free spooling
- Sealed motor and drivetrain
- Low-voltage contactor
- Integrated wiring and mount plates ensure perfect fit

POLARIS® PRO HD 4500 LB. WINCH

- 4500 lbs of pulling capacity
- Auto stop technology — ideal for snow plowing applications
- 50' of 6mm premium high strength synthetic rope
- High quality polished aluminum fairlead
- Integrated design to Polaris® RZR®
- Fully sealed contactor, motor and drivetrain
- 6 gauge wiring maximizes current flow
- Low speed gearing for optimized plow control
- Cut metal gears for maximum durability
- Durable corrosion resistant finish
- Corded remote control with socket
- 1 year warranty
- Includes all components required for installation

2880053 **NEW**

RZR® XP 4 1000 MY 14-15

2879462

RZR® XP 1000 MY 14-15, RZR® 900 MY 15, RZR® S 900 MY 15

2879186

RZR® 900 MY 11-14, RZR® 900 4 MY 12-14



PRO PRO HEAVY DUTY SERIES

4500 LB. WINCH



WARN

4500 LB. WINCH



WARN® PROVANTAGE 4500 LB. WINCH **NEW**

- WARN® PROVANTAGE winch optimized for Polaris® RZR®
- 4500 lbs of pulling capacity
- Fully sealed contactor, motor & drivetrain
- 50' of 7/32" high strength aircraft quality steel cable
- Three-stage planetary gear train for smooth efficient operation
- All metal gear housing and gears for maximum durability
- Durable corrosion resistant finish
- Oversized hook for maximum durability
- Ergonomic clutch handle
- Patented roller disc brake
- Corded remote control with socket
- Limited life time warranty for mechanical components. Limited 3 year warranty for electrical components
- Includes all components required for installation

2880789

RZR® XP 4 1000 MY 14-15

2880592

RZR® XP 1000 MY 14-15

2880590

RZR® 900 MY 15, RZR® S 900 MY 15, RZR® 900 XC MY 15

2880582

RZR® 570 MY 11-15, RZR® 800 MY 08-14

HD HEAVY DUTY SERIES

3500 LB. WINCH

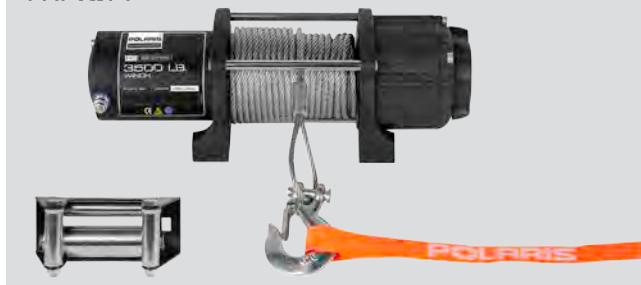

POLARIS® HD 3500 LB. WINCH

- 3500 lbs of pulling capacity
- Integrated design to Polaris® RZR®
- Fully sealed contactor, motor and drivetrain
- 6 gauge wiring maximum current flow
- 50' of 3/16" high strength steel cable
- Cut metal gears for maximum durability
- Durable corrosion resistant finish
- 6 gauge wiring maximum current flow
- Low speed gearing for optimized plow control
- Corded remote control with socket
- 1 year warranty
- Performance upgrades; synthetic rope, auto stop, wireless remote and plow rope (sold separately)
- Includes all components required for installation

2880052 **NEW**

RZR® XP 4 1000 MY 14-15

2879461

RZR® XP 1000 MY 14-15, RZR® 900 MY 15, RZR® S 900 MY 15, RZR® 900 XC MY 15

2879335

RZR® 900 MY 11-14, RZR® 900 4 MY 12-14

2879334

RZR® 570 MY 11-15, RZR® 800 MY 08-14, RZR® S MY 09-14, RZR® 4 MY 10-14

WARN

3500 LB. WINCH



WARN® PROVANTAGE 3500 LB. WINCH **NEW**

- WARN® PROVANTAGE winch optimized for Polaris® RZR®
- 3500 lbs of pulling capacity
- Fully sealed contactor, motor & drivetrain
- 50' of 3/16" high strength aircraft quality steel cable
- Three-stage planetary gear train for smooth efficient operation
- All metal gear housing and gears for maximum durability
- 6 gauge wiring maximizes current flow
- Durable corrosion resistant finish
- Oversized hook for maximum durability
- Ergonomic clutch handle
- Patented roller disc brake
- Corded remote control with socket
- Limited life time warranty for mechanical components. Limited 3 year warranty for electrical components
- Includes all components required for installation

2880788

RZR® XP 4 1000 MY 14-15

2880593

RZR® XP 1000 MY 14-15

2880591

RZR® 900 MY 15, RZR® S 900 MY 15, RZR® 900 XC MY 15

2880583

RZR® 570 MY 11-15, RZR® 800 MY 08-14

POLARIS® PRO HD WINCH UPGRADE KIT

- Upgrade your existing Polaris® HD Winch with the premium features of a PRO HD.
- Auto-Stop technology stops winch to eliminate stress on driveline components
- Winch stops when Auto-Stop Collar on rope contacts fairlead
- Auto-Stop prevents overlifting of plows, over-retrieving on pulls
- Corrosion-free, polished aluminum Hawse™ fairlead

2879149

3500 LB. WINCH

Requires use of Winch Rope 2875791 (not included)



WINCH ROPE

- Polaris® winch ropes are designed to work with the Polaris® winch of the same rating. Always use the rope that is sized appropriately for your winch.

2879187

4500 LB. WINCH

2875791

3500 LB. WINCH



LIGHTING



27" DUAL ROW LIGHT BAR

- 5-watt LED lights with max output of 21,000 lumens
- Custom combination of spot and flood lenses provide optimal light-beam projection
- Integrated mounting locations on roofs; see wire harness chart for required harness
- Includes Light Bar, mounting hardware and installation instructions

2879858

ALL RZR[®] MODELS

21,000
Lm

Requires LED harness (sold separately).
See harness chart on page 45 for specifics.
Installation instructions are included with the LED harness.

35" LED LIGHT BAR **NEW**

- Convenient, versatile lighting that will enhance your riding experience
- 35" LED Light Bar elevates the vehicle's sporty, high-performance style
- Polaris[®] exclusive & manufactured by Vision X
- Installs quickly & easily into designated mounting locations and connects to vehicle's electrical system
- Delivers reliable performance & outstanding value
- Dust proof and waterproof up to one meter; tested to IP67 standards
- Premium 5 watt CREE XPG-2 LEDs
- 35.43" x 2.76" x 2.17" (90 cm x 7 cm x 5.5 cm)

2880527

ALL RZR[®] MODELS

9504
Lm

Requires LED harness (sold separately).
See harness chart on page 45 for specifics.
Installation instructions are included with the LED harness.

13" LED LIGHT BAR **NEW**

- Convenient, versatile lighting that will enhance your riding experience
- 13" LED Light Bar elevates the vehicle's sporty, high-performance style
- Polaris[®] exclusive & manufactured by Vision X
- Installs quickly & easily into designated mounting locations and connects to vehicle's electrical system
- Delivers reliable performance & outstanding value
- Dust proof and waterproof up to one meter; tested to IP67 standards
- Premium 5 watt CREE XPG-2 LEDs
- 13.39" x 2.76" x 2.17" (34 cm x 7 cm x 5.5 cm)

2880530

ALL RZR[®] MODELS

3168
Lm

Requires LED harness (sold separately).
See harness chart on page 45 for specifics.
Installation instructions are included with the LED harness.

7" LED LIGHT BAR **NEW**

- Convenient, versatile lighting that will enhance your riding experience
- 7" LED Light Bar elevates the vehicle's sporty, high-performance style
- Polaris[®] exclusive & manufactured by Vision X
- Installs quickly & easily into designated mounting locations and connects to vehicle's electrical system
- Delivers reliable performance & outstanding value
- Dust proof and waterproof up to one meter; tested to IP67 standards
- Premium 5 watt CREE XPG-2 LEDs
- 6.69" x 2.76" x 2.17" (17 cm x 7 cm x 5.5 cm)

2880624

ALL RZR[®] MODELS

1584
Lm

Requires LED harness (sold separately).
See harness chart on page 45 for specifics.
Installation instructions are included with the LED harness.

2" LED LIGHT

- 10-watt LED light
- Max output of 900 lumens
- Weatherproof connectors with plug-and-play harness
- Die-cast aluminum housing with interlocking omni-link system and stainless steel hardware

2878715

ALL RZR[®] MODELS

900
Lm

Requires LED harness (sold separately).
See harness chart on page 45 for specifics.
Installation instructions are included with the LED harness.

RALLY LIGHTS

- 4" (10.2 cm) lens with 35-watt halogen bulb
- Sold individually

2877335

ALL RZR[®] MODELS

900
Lm

Requires Brushguard Wire Harness 2877910.
See harness chart on page 45 for specifics.
Installation instructions are included with the LED harness.



LIGHTING



ROOF-MOUNTED REAR BRAKE LIGHT

- LED high output for increased visibility
- Integrated mounting into accessory roofs
- Easy installation with vehicle wiring harness
- Material is durable, sealed, hard-plastic housing
- Mounts on rear edge of roof (sold separately)
- Includes brake light, wiring and installation instructions
- Features brake light and running light for increased visibility whenever the lights are on

2880702

RZR® XP 1000 MY 14-15, RZR® XP 4 1000 MY 14-15, RZR® 900 MY 15, RZR® S 900 MY 15, RZR® 900 XC MY 15



LED HEADLIGHT KIT **NEW**

- Unique, innovative Polaris®-exclusive design and technology
- Replaces the stock headlights and provides brighter, more powerful lighting
- These lights use innovative angled reflectors instead of optics to cast a broader, brighter, more-effective light beam
- Provides greater visibility of your surroundings
- Makes your vehicle more visible to those nearby, especially other vehicle traffic

2880485

RZR® 900 MY 15, RZR® S 900 MY 15, RZR® 900 XC MY 15

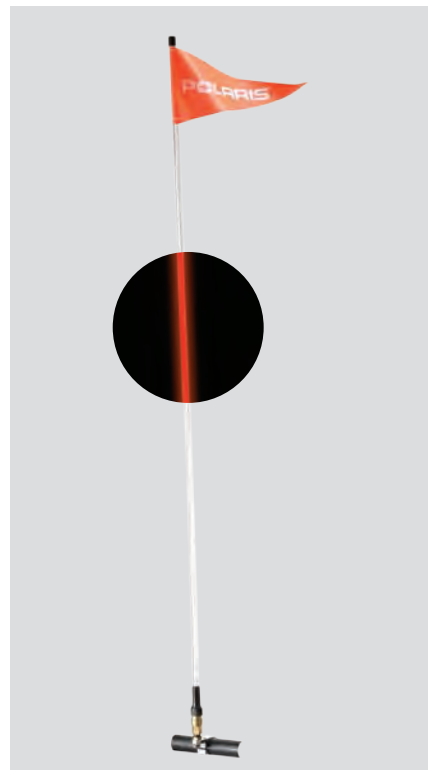

LIGHTED WHIP FLAG

- Enhances visibility; ideal for hills and dunes
- Includes wiring harness and switch
- May require 2878907 or 2878906 based on mounting location

2878772

ALL RZR® MODELS

Non-Lighted Whip Flag can be found on page 55



LIGHT BAR MOUNT

- This mount accommodates the installation of a wide variety of light bars (sold separately) when a roof is not installed
- Mount installs in designated, integrated location using provided fasteners

2879732

RZR® XP 1000 MY 14-15, RZR® XP 4 1000 MY 14-15, RZR® 900 MY 15, RZR® S 900 MY 15, RZR® 900 XC MY 15

See wire harness chart

2878275

RZR® 570 MY 12-15, RZR® 800 MY 09-14, RZR® S MY 09-14, RZR® 4 MY 10-14

Lighting harness sold separately, see chart on page 45



BILLET CLAMPS

- Premium look and secure, reliable performance
- Sold individually

2878907 | 1.75" Frame

ALL RZR® MODELS

2878906 | 1.5" Frame

RZR® 570 MY 12-15, RZR® 800 MY 08-14, RZR® 4 MY 10-14, RZR® 900 MY 11-15, RZR® 900 4 MY 12-14



LIGHTING HARNESSES

	27" 5W Dual Stack LED Light Bar	35" 5W LED Light Bar	13" 5W LED Light Bar	7" 5W LED Light Bar	2" 10W LED Light Bar	Rally Light
Harness Needed for RZR® XP 1000, RZR® 900 TRAIL, RZR® S 900	2879865 or 2879859	2879865 or 2879859	2879865 or 2879859	2879860 and 2879865	2879860 and 2879865	2877910
Busbar Kit Needed for RZR® XP 1000*, RZR® 900 TRAIL, RZR® S 900 (if not already installed)	2879862	2879862	2879862	2879862	2879862	NA
Harness Needed for all other RZR®	2879863	2879863	2879863	2878770 or 2879863	2878770 or 2879863	2877910

*Busbar kit comes with the purchase of RZR® XP 1000 PRO HD and HD winches (2879461, 2879525, 2879462) and MTX® Audio Systems (2879826, 2879459).

BUSBAR HARNESS (NOT SHOWN)

- The Busbar Harness is required for the installation of larger LED light bars (2880527, 2879858)
- This wire harness kit allows for additional power draw from the busbar

2879862

RZR® XP 1000 MY 14-15, RZR® 900 MY 15, RZR® S 900 MY 15, RZR® 900 XC MY 15

2880055

RZR® XP 4 1000 MY 14-15

LED HARNESS (NOT SHOWN)

- This wire harness is designed to seamlessly route through the RZR® XP 1000 cab frame so no loose wires are exposed
- Includes rocker switch and connection for one LED light bar

2879859

RZR® XP 1000 MY 14-15, RZR® 900 MY 15, RZR® S 900 MY 15, RZR® 900 XC MY 15

DELUXE LED HARNESS (NOT SHOWN)

- Includes two rocker switches, radio harness and connection for two LED light bars
- Ideal harness for multiple LED light bars and audio system

2879865

RZR® XP 1000 MY 14-15, RZR® 900 MY 15, RZR® S 900 MY 15, RZR® 900 XC MY 15

DUAL LED HARNESS (NOT SHOWN)

- This harness needs to be used in addition to LED Harness 2879559 or Deluxe LED Harness 2879865
- This harness allows for two LED light bars to be controlled by one switch

2879860

RZR® XP 1000 MY 14-15, RZR® 900 MY 15, RZR® S 900 MY 15, RZR® 900 XC MY 15

2878770

RZR® 570 MY 12-15, RZR® 800 MY 08-14, RZR® 4 MY 10-14, RZR® 900 MY 11-15, RZR® 900 4 MY 12-14

RZR® UNIVERSAL LED HARNESS (NOT SHOWN)

- This harness is required for installation of LED Headlight Kits (sold separately) on your Polaris® RZR®
- Includes rocker switch and connection for one LED light bar

2879863

RZR® 570 MY 12-15, RZR® 800 MY 08-14, RZR® 4 MY 10-14, RZR® 900 MY 11-15, RZR® 900 4 MY 12-14

BRUSHGUARD WIRE HARNESS (NOT SHOWN)

- This wire harness only works with Rally Lights 2877335
- Kit for mounting lights to brushguard
- Includes 2 connectors, auxiliary switch

2877910

ALL RZR® MODELS

STORAGE & INTERIORS

CARRY MORE CARGO. WHETHER YOU'RE STORING SOMETHING BIG OR SMALL IN YOUR RZR®, THERE'S A LOCK & RIDE® BOX OR BAG THAT WILL INSTALL IN SECONDS TO MAKE THE MORE OF YOUR EXPERIENCE.



LOCK & RIDE® REAR COOLER BOX

- Stay hydrated and refreshed on the trail with this RZR® cooler storage box. Uses Lock & Ride® Technology and has a built-in drain.
- One-piece UV resistant roto-molded construction for extreme durability
- Lock & Ride®: Installs easily to securely transport cooler to and from your destination
- Extra thick walls with pressure-injected insulation for maximum ice retention
- Chest is able to keep food and beverages cool for 48+ hours
- Handles make it easy to carry to and from your machine
- 48-quart cooler capacity
- Easy-to-use rubber lockable latches and heavy-duty hinges
- Gray color absorbs less sunlight and keeps ice longer

2880018
RZR® XP 1000 MY 14-15



LOCK & RIDE® REAR COOLER BOX **NEW**

- Stay hydrated and refreshed on the trail with this RZR® cooler storage box; uses Lock & Ride® Technology and has a built-in drain
- One-piece UV-resistant roto-molded construction for extreme durability
- Lock & Ride®: Installs easily to securely transport cooler to and from your destination
- Extra thick walls with pressure-injected insulation for maximum ice retention
- Dual-action lid to accommodate for use with other accessories such as spare tire carrier
- Chest is able to keep food and beverages cool for 48+ hours
- Handles make it easy to carry to and from your machine
- 51-quart cooler capacity
- Easy-to-use rubber lockable latches and heavy-duty hinges
- Gray color absorbs less sunlight and keeps ice longer

2880440
RZR® 900 MY 15, RZR® S 900 MY 15, RZR® 900 XC MY 15



LOCK & RIDE® CARGO BOX

- Strong one-piece roto-molded construction for extreme durability
- Lid latches securely in place with rubber lockable latches to protect cargo
- Lid has heavy-duty hinges and a weatherproof seal to block moisture and dust
- Cargo box is UV-resistant so it won't fade in the sun
- Lock & Ride®: Installs quickly and easily
- Integrated grab handles make it easy to carry box to and from your RZR®
- 48-quart capacity

2879997
RZR® XP 1000 MY 14-15, RZR® XP 4 1000 MY 14-15



LOCK & RIDE® CARGO BOX **NEW**

- Strong one-piece roto-molded construction for extreme durability
- Lid latches securely in place with rubber lockable latches to protect cargo
- Lid has heavy-duty hinges and a weatherproof seal to block moisture and dust
- Cargo box is UV-resistant so it won't fade in the sun
- Lock & Ride®: Installs quickly and easily
- Integrated grab handles make it easy to carry box to and from your RZR®
- Dual-action lid to accommodate for use with other accessories such as spare tire carrier
- 51-quart capacity

2880158
RZR® 900 MY 15, RZR® S 900 MY 15, RZR® 900 XC MY 15



CENTER CONSOLE BOX

- Strong, durable construction provides convenient, protected cargo space between the seats
- Dual compartments provide various storage options ideal for holding maps, gloves, goggles, glasses, caps, wallets and more

2879120
RZR® XP 1000 MY 14-15, RZR® XP 4 1000 MY 14-15



LOCK & RIDE® CARGO BOX

- Strong one-piece roto-molded construction for extreme durability
- Lid latches securely in place with rubber lockable latches to protect cargo
- Lid has heavy-duty hinges and a weatherproof seal to block moisture and dust
- Dual-action lid has an integrated storage space with its own lid
- Cargo box is UV-resistant so it won't fade in the sun
- Lock & Ride®: Installs quickly and easily
- Integrated grab handles make it easy to carry box to and from your RZR®

2876439-070
RZR® 570 MY 12-15, RZR® 800 MY 08-14, RZR® S MY 09-14, RZR® 4 MY 10-14



STORAGE & INTERIORS



UPPER DOOR STORAGE BAG **NEW**

- Installs conveniently on inside of door, putting storage within easy reach
- Storage bags mount easily and provide zippered storage spaces for small items
- Bags are Polaris®-branded

2880612

RZR® XP 1000 MY 14-15, RZR® S 900 MY 15, RZR® 900 XC MY 15



LOWER DOOR STORAGE BAG **NEW**

- Installs conveniently on inside of accessory lower door, putting storage within easy reach
- Storage bags mount easily and provide zippered storage spaces for small items
- Bags are RZR®-branded

2880613

RZR® XP 1000 MY 14-15, RZR® S 900 MY 15, RZR® 900 XC MY 15

2880616

RZR® 900 MY 15

2880613 requires lower door inserts (2879509, sold separately)

2880616 requires lower door inserts (2880207, sold separately)



OVERHEAD BAG

- Polyester fabric with carbon-fiber look
- Multiple pockets and weatherproof zippers
- Waterproof compartment with window for valuables
- Sealed audio port allows for use of phone or audio device
- Easy install with Velcro® attachments and fiberglass rods for reinforcement

2879516 | Black

RZR® XP 1000 MY 14-15, RZR® 900 MY 15, RZR® S 900 MY 15, RZR® 900 XC MY 15



DOOR LINERS **NEW**

- Durable, weatherproof construction for reliable performance during off-road riding
- Upper Door Liners feature modest padding to provide passengers with enhanced comfort while riding
- Liners are styled to coordinate with upholstery of vehicle's rear seats for a finished, integrated look
- Liners install easily, attaching to interior door framework
- Upper Door Liners are branded with Polaris® logo, Lower Door Liners are branded with RZR® logo

2879431 | Upper Front Door Liners

RZR® S 900 MY 15, RZR® 900 XC MY 15, RZR® XP 1000 MY 14-15, RZR® XP 4 1000 MY 14-15

2880703 | Upper Rear Door Liners

RZR® XP 4 1000 MY 14-15

2879433 | Lower Front Door Liners

RZR® S 900 MY 15, RZR® 900 XC MY 15, RZR® XP 1000 MY 14-15, RZR® XP 4 1000 MY 14-15

2880704 | Lower Rear Door Liners

RZR® XP 4 1000 MY 14-15

2879433 only fits with Lower Door Inserts (2879509)

2880704 only fits with Lower Door Inserts (2879942)



SHOULDER STORAGE BAG

- Fits between seats, attaches with clips
- Interior mesh pockets store small items
- Easy to install, remove and take along
- Perfect for storing your GPS, gloves, cell phone and more

2878352

RZR® 570 MY 12-15, RZR® 800 MY 08-14, RZR® 4 MY 10-14, RZR® 900 MY 11-14, RZR® 900 4 MY 12-14



OVERHEAD MAP BAG

- Storage bag for maps, GPS, other small items
- Attaches to cab frame with Velcro® straps
- Easy to install, remove and take along

2878351

RZR® 570 MY 12-14, RZR® 800 MY 08-14, RZR® S MY 09-14, RZR® 900 MY 11-14



SIDE BAG

- Polyester fabric with carbon-fiber look
- Dust resistant zippers with access from both inside and outside the vehicle
- Easy install with Velcro® attachments
- Great for storing tools with an integrated elastic tool strap

2879518 | Black

RZR® XP 1000 MY 14-15, RZR® XP 4 1000 MY 14-15



SPARE TIRE CARRIER

- Material is steel
- Mounts on the rear cab frame in under 5 minutes using 4 provided clamps
- Includes mounting hardware
- Easily pivots to access cargo area

2879464 | Black

RZR® XP 1000 MY 14-15, RZR® XP 4 1000 MY 14-15

2880148 **NEW**

RZR® 900 MY 15, RZR® S 900 MY 15, RZR® 900 XC MY 15

2880148 requires Upper Cab Frame Extension 2880411 and either Lower Cab Frame Extension 2880412 or Deluxe Rear Bumper, 2880164 with Bumper Adapter, 2880165 (all sold separately)



SPARE TIRE CARRIER

- Provides a strong, reliable, location to carry a spare tire while riding
- Tube-steel construction with black powder-coat finish that complements vehicle framework and Cab Frame Extension
- Keeps cargo space free to hold other belongings
- Installs on accessory Cab Frame Extension (required and sold separately)

2878563

RZR® 570 MY 12-15, RZR® 900 MY 11-14, RZR® 900 4 MY 12-14



KOLPIN® GUN BOOTS

- Securely protects and holds firearm
- Works with shotgun or rifle
- Padded interior, dust-proof, water-resistant

2872677-419 | Mossy Oak®

ALL RZR® MODELS

2872677 | Black

ALL RZR® MODELS



GUN SCABBARD MOUNT **NEW**

- Safely and securely carry firearm scabbards by attaching them to the Cab Frame Extension Upper Section (Scabbards and Cab Frame Extension sold separately)
- Gun Scabbard Mount installs easily and holds one or two scabbards
- Strong, durable, black powder-coated scabbard mount coordinates with the style of the extension and vehicle framework

2880313

RZR® 900 MY 15, RZR® S 900 MY 15, RZR® 900 XC MY 15

Fits with Lock & Ride® Cargo and Cooler boxes but interferes with complete lid opening when gun boots are in place



LOCK & RIDE® FLAG MOUNT

- Expansion anchor allows easy on/off
- Holds whip flag, required in some areas

2877502

ALL RZR® MODELS



BED D-RINGS

- Creates additional tie-down points in box
- Makes securing cargo quick and easy
- Kit includes 4 D-rings and hardware

2877460

ALL RZR® MODELS

POLARIS® INNOVATION

TECHNOLOGY AT YOUR FINGERTIPS FOR YOUR COMFORT, CONVENIENCE AND SAFETY. BECOME FULLY CONNECTED TO YOUR MACHINE – BECOME FULLY CONNECTED TO YOUR RIDE – EVERY STEP OF THE WAY.



POLARIS® INTERACTIVE DIGITAL DISPLAY **NEW**

Simple and seamless — Polaris® has developed the first of its kind; this display will put you at the center of your riding experience in a whole new way.

- 4.3" high-resolution, full-color, LCD digital display
- Smartphone connectivity* via Bluetooth™ displays text message and missed call indicator, phone battery life and cell signal strength
- Diagnostics screen displays vehicle fault codes, descriptions and suggested actions to resolve issues
- Vehicle Immobilizer and security function allow you to lock your vehicle with a passcode
- GPS Connectivity offers exact location information including elevation, latitude/longitude, compass bearings, as well as recording your route so you can find trails again

RZR® catalog page 51

RZR® XP 1000 MY 14-15, RZR® XP 4 1000 MY 14-15, RZR® 900 MY 15, RZR® S 900 MY 15, RZR® XC 900 MY 15

Must purchase RZR Install Kit 2880497

POLARIS® INTERACTIVE DIGITAL DISPLAY INSTALL KIT **NEW**

- Includes all new instrument panel, necessary mounting hardware, wiring harness, etc. to install the Polaris® Interactive Digital Display

2880497

RZR® XP 1000 MY 14-15, RZR® XP 4 1000 MY 14-15, RZR® 900 MY 15, RZR® S 900 MY 15, RZR® XC 900 MY 15

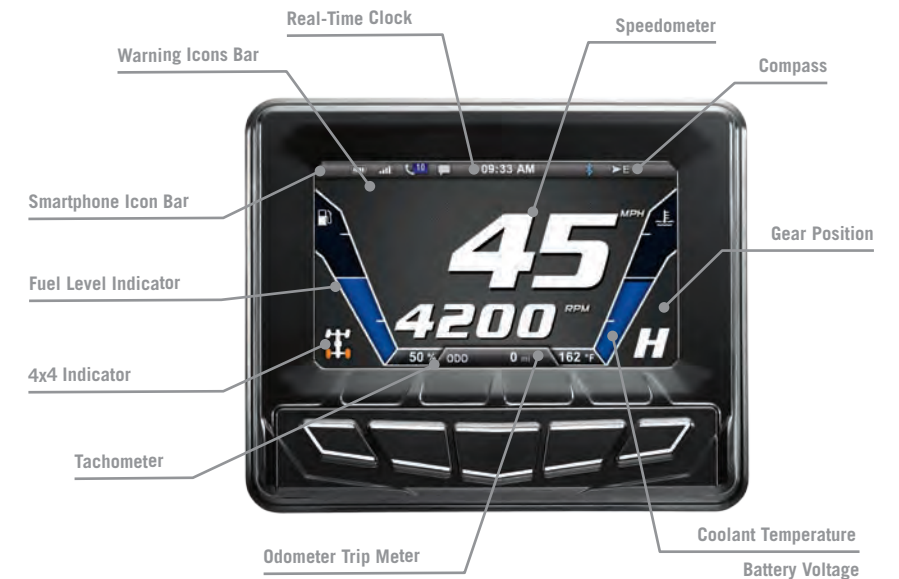

Plan and record your route so you can find trails again



Check missed calls and text messages without pulling out your phone

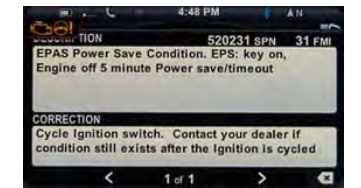

Diagnostics screen displays fault codes and suggested actions to take

COMING SOON

POLARIS® LINK **NEW** POWERED BY RIDERX™

Become integrated into your riding experience with the Polaris® Link, powered by RiderX™. The wireless link easily plugs into your vehicle to record diagnostics and information. The data is transferred wirelessly via Bluetooth™ to your cellular device, where you review with your RiderX™ mobile application.* Polaris Link supplies data to your phone wirelessly from your machine including:

- Real-Time Gauge with speed, RPM and average miles per gallon
- Vehicle Statistics including fuel rate, battery voltage and engine hours
- Vehicle Diagnostics that display error codes and preferred dealer communication

*Full functionality requires compatible Bluetooth™ smartphones

POLARIS® WIRELESS LINK HARNESS **NEW**

- Wiring harness connects Polaris® Wireless Link for most versatile connection in the greatest number of off-road locations to your machine
- Harness connects easily to vehicle electrical system and to the link

To download the RiderX™ app

TEXT DRV1



TO 82350



POLARIS®

ENGINEERED PARTS
ACCESSORIES & APPAREL

AUDIO



Polaris® has partnered with MTX® Audio to supply you with industry-leading audio solutions for your RZR®. MTX® Audio shares the Polaris Engineered™ values of delivering innovative, quality products that fit right, install easily and stand out against the competition. Choose from a variety of options that best fit your needs, whether it be a 2-speaker overhead audio pod, full audio system complete with 4 overhead speakers and subwoofer or our all new premium audio roof with stylish lines that blend seamlessly with your RZR® and integrated LED light bars and taillights to keep you riding longer.

Polaris® and MTX® are committed to providing you with an outstanding, premium product that exceeds expectations and offers a truly remarkable listening experience wherever your RZR® takes you.

INDUSTRY-LEADING SOUND QUALITY

Full range sound experience with extended low frequency reproduction for bigger, fuller sound

RIDER-FOCUSED ERGONOMICS

Volume controls, glove-friendly buttons and overhead LED lighting designed with the rider top of mind

BLUETOOTH® TECHNOLOGY

Sync your smartphone and control your music from a distance with Bluetooth® connectivity

DURABLE, QUALITY CONSTRUCTION

Marine-grade construction designed to be extremely weather-resistant and handle the toughest outdoor conditions

PREMIUM AUDIO ROOF **NEW**

- The most versatile single accessory ever offered, providing protection, comfort, style, storage, lighting and premium audio
- Strong, durable black molded-poly roof provides shade and reliable overhead protection
- Roof is styled to complement the sporty look of the RZR®
- Roof mounts easily on the vehicle frame in designated locations using provided hardware
- Audio system is completely integrated under the roof
- Audio head unit positioned at front of roof with controls within reach of driver and passenger
- Audio is delivered through four powerful 400W 6x9 speakers with 55Hz-20kHz frequency response
- Accessory subwoofer (2880502; sold separately) can be mounted under the dash for enhanced output
- Auxiliary lighting is integrated in recesses at the front and rear of the roof
- Front of roof houses three light bars
- Rear of roof has taillights and powerful LED floodlight
- Under roof integrated sealed storage that is foam padded and safely secures small items and electronics up to tablet size
- Integrated USB charging, interior LED lighting and bluetooth connectivity
- Premium 3 Watt, 12 Volt LED Lights
- Dust proof and protected from low pressure water jets (6.3mm nozzle), tested to IP65 standards
- 9 Center LEDs are 2052 lumens and 3 Outer LEDs are 684 lumens

2880417

RZR® XP 1000 MY 14-15, RZR® 900 MY 15, RZR® S 900 MY 15, RZR® 900 XC MY 15

AVAILABLE OCTOBER 2014



Glove-Friendly Controls



Speaker Set Up with Tablet Storage Box



Rear Tail Lights And Utility Light



MTX® COMPLETE AUDIO SYSTEM

- Includes: Overhead Audio Pod, Rear Two Speaker Add-On and Powered Subwoofer
- Waterproof marine-grade construction
- Oversized buttons and back-lit display for easy operation
- Two fully-sealed storage compartments for phone storage
- 2 directional high-output tweeters
- USB charging and Bluetooth® connectivity capability
- Mounts on cab frame in designated mounting positions for easy installation

2879826 | Black

RZR® XP 1000 MY 14-15, RZR® 900 MY 15, RZR® S 900 MY 15, RZR® 900 XC MY 15

A. MTX® OVERHEAD AUDIO POD

- Fully-sealed, injection-molded enclosure with marine-grade components
- 50Wx2 power
- Fully-sealed dry storage locker
- Mounts on cab frame in designated mounting positions
- Bluetooth® connectivity
- Full audio display
- Includes Overhead Audio Pod, wiring, mounting hardware and instructions
- Less than 15-minute, easy installation

2879459 | Black

RZR® XP 1000 MY 14-15, RZR® 900 MY 15, RZR® S 900 MY 15, RZR® 900 XC MY 15

B. REAR TWO SPEAKER ADD-ON

- Fully-sealed, injection-molded enclosure with marine-grade components
- Fully-sealed dry storage locker
- Speakers plug directly into Overhead Audio Pod (sold separately)
- Includes Two Speaker Add-On, wiring, mounting hardware and instructions
- Less than 15-minute, easy installation

2879514 | Black

RZR® XP 1000 MY 14-15

C. MTX® POWERED SUBWOOFER **NEW**

- Marine-grade, fully sealed, rotationally molded plastic enclosure offers deeper molded housing for improved bass output and audio quality
- High-output speaker for elevated volume without compromising audio quality
- Subwoofer mounts under vehicle dash/glove box and connects to Overhead Audio Pod (sold separately 2879459)
- 200W digital low-draw amp

2880502

RZR® XP 1000 MY 14-15, RZR® 900 MY 15, RZR® S 900 MY 15, RZR® 900 XC MY 15

RZR XP 4 AUDIO EXTENSION CABLE **NEW**

- Connects Two Speaker Add-On to MTX® overhead audio pod

2879941

RZR® XP 4 1000 MY 14-15

POLARIS

ENGINEERED PARTS
ACCESSORIES & APPAREL

COMFORT & ELECTRONICS

THE LITTLE THINGS MAKE A BIG DIFFERENCE WHEN IT COMES TO MAKING MORE OF YOUR MACHINE. ACCESSORIES LIKE GPS WITH POLARIS®-EXCLUSIVE OFF-ROAD MAPPING AND HIGH-PERFORMANCE SEATS MAKE YOUR RZR® BETTER THAN EVER.



PERFORMANCE SEATS

- High-performance suspension seat for improved ride comfort
- Increased side bolstering to securely hold you in place
- Waxed seam construction to reduce water absorption
- Accepts stock seatbelts or aftermarket 4- and 5-point harnesses

2879445 | Black/Graphite

RZR® XP 1000 MY 14-15, RZR® XP 4 1000 MY 14-15, RZR® 900 MY 15, RZR® S 900 MY 14, RZR® 900 XC MY 15

2879521 | Black/Orange

RZR® XP 1000 MY 14-15, RZR® XP 4 1000 MY 14-15, RZR® 900 MY 15, RZR® S 900 MY 14, RZR® 900 XC MY 15



CLICK-6 HARNESSES **NEW**

- Racing-quality premium construction for the greatest security and protection
- Six straps hold a driver securely in place in all riding conditions
- Each strap is individually adjustable for the best custom fit
- Dual shoulder straps have camlock mechanism to hold driver in place, acting like a seat belt to keep the driver's hips securely on the seat
- One-click, quick-release buckle releases straps, allows for easy egress
- Shoulder straps feature RZR® branding

2879854 | Driver Side

RZR® XP 1000 MY 14-15, RZR® 900 MY 15, RZR® S 900 MY 14, RZR® 900 XC MY 15

2880470 | Passenger Side

RZR® XP 1000 MY 14-15, RZR® 900 MY 15, RZR® S 900 MY 14, RZR® 900 XC MY 15



PERFORMANCE STEERING WHEEL

- Racing-inspired design with carbon fiber wrap
- Adds a sporty look and provides a sure, comfortable grip
- Requires Steering Wheel Adapter Hub 2879341 (sold separately)
- 2879994 wheel gives an additional 1" offset

2879206

ALL RZR® MODELS

2879994

ALL RZR® MODELS



HORN KIT

- Powerful, reliable horn alerts others to your presence as needed
- Horn installs near front end of vehicle
- Operation button installs in designated location on console, within easy reach of the driver
- Connects to vehicle's electrical system for power

2880416 **NEW**

RZR® XP 1000 MY 14-15, RZR® XP 4 1000 MY 14-15, RZR® 900 MY 15, RZR® S 900 MY 15, RZR® 900 XC MY 15

2877788

RZR® 570, RZR® 800, RZR® S, RZR® 4, RZR® 900 4



1" WHEEL SPACER **NEW**

- Additional 1" offset to performance steering wheel (shown above) for 2" total additional offset

2879995

ALL RZR® MODELS

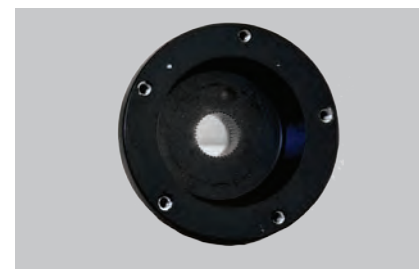

STEERING WHEEL ADAPTER HUB

2878522

ALL RZR® MODELS



SEATBELT PAD

- Added comfort for long rides
- Easy Velcro® attachment

2880161 | BLACK

Vinyl fabric with stylish carbon-fiber look
ALL RZR® MODELS

2880160 | CARBON

Neoprene fabric offers soft non-abrasive comfort
ALL RZR® MODELS



Screws together for easy assembly and storage

WHIP FLAG

- Maximizes visibility on hilly terrain
- 2-piece kit: 8' whip and bright flag

2878799

ALL RZR® MODELS

Mount with Billet Clamps 2878907 or 2878906



UNDERDASH BLOCKOFF KIT

- Blocks gap between floor and under the dash
- Reduces airflow, prevents gravel and water from entering

2876900

ALL RZR® MODELS EXCEPT RZR® XP 1000 AND RZR® 900 WITH EPS

COMFORT & ELECTRONICS

HEATER KIT

- Enjoy heat on demand to enhance your comfort during cold-weather riding and seasonal shut off for warm-weather riding
- Adjustable settings let riders control warm air flow
- Installs under dash and utilizes engine coolant as its heat source
- Includes everything needed for proper installation and reliable operation

2880534

RZR® XP 1000 MY 14-15, RZR® XP 4 1000 MY 14-15, RZR® 900 MY 15, RZR® S 900 MY 15, RZR® 900 XC MY 15



EPS KIT

- Polaris®-exclusive Electric Power Steering kit provides smooth, easy, precisely responsive automotive-quality steering
- EPS provides a light steering feel in all situations, including low-speed maneuvering through challenging terrain
- Dampens steering feedback to greatly reduce driver fatigue

2879522 **NEW**

RZR® 900 MY 15, RZR® S 900 MY 15, RZR® 900 XC MY 15

2878905

RZR® 570 MY 12-14, RZR® 800 MY 11-14, RZR® 800 4 MY 11-14, RZR® S 800 MY 11-14

2878522

RZR® 900 MY 11-14, RZR® 900 4 MY 12-14

2878204

RZR® 800 MY 09-10, RZR® S MY 09-10



WINDSHIELD WIPER KIT **NEW**

- Combination of windshield wiper and washer reservoir makes sure your windshield is always clear
- The wiper can be used to clear rain, snow and other wet debris
- The washer provides fluid to help clean dirt, mud, dust and more off the windshield and integrates into the dash

2879526

RZR® XP 1000 MY 14-15, RZR® XP 4 1000 MY 14-15, RZR® 900 MY 15, RZR® S 900 MY 15, RZR® 900 XC MY 15

Requires Glass Windshield 2879447

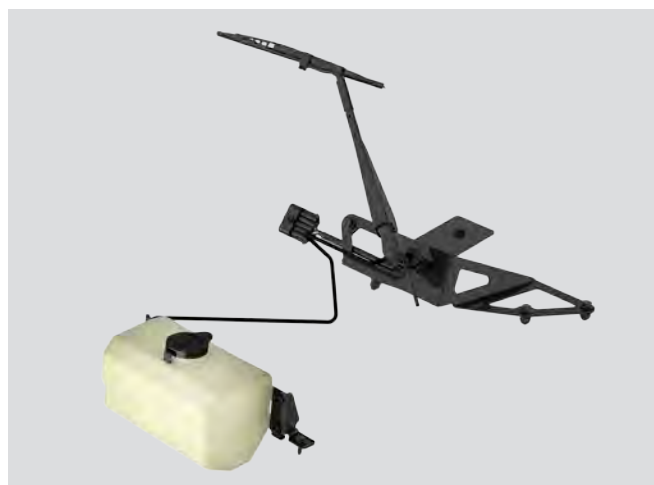

SEAT SLIDER

- Strong, durable, proven reliable construction
- Seat mounts securely to Seat Slider, then can be moved forward or backward
- Allows rider to position the seat in the ideal location for optimized comfort and control
- Installs easily: Seat Slider bolts solidly to floor of vehicle, seat bolts to slider
- Works with stock or Polaris® Performance Seats
- Sold individually; purchase two to provide driver and passenger with seat adjustability

2879460 **NEW**

RZR® XP 1000 MY 14-15, RZR® XP 4 1000 MY 14-15, RZR® 900 MY 15, RZR® S 900 MY 15, RZR® 900 XC MY 15

SEAT ADJUSTMENT KIT

2877390

RZR® 570 MY 11-15, RZR® 800 MY 08-14, RZR® 4 MY 10-14, RZR® 900 MY 11-15, RZR® 900 4 MY 12-14



CONVEX REAR VIEW MIRROR **NEW**

- Durable, weatherproof construction, designed to perform in all off-road riding conditions
- Installs easily: Mount bolts into your choice of pre-designated mounting locations on vehicle frame
- Mirror attaches to mount and is adjustable
- Convex design provides broad, expanded view of what's behind or alongside the vehicle
- Can be used with all roofs, soft tops and windshields
- Scratch-resistant glass mirror lens

2880531

ALL RZR® MODELS



SIDE MIRRORS

- Clamps to stock cab frame
- Durable aluminum construction with aggressive styling
- Fully adjustable housing to accommodate different riders
- Powder-coated billet aluminum
- Sold in pairs

2879528 | Black

ALL RZR® MODELS



ALL-WEATHER FLOOR MATS **NEW**

- Strong, durable molded plastic construction
- Mats are custom-molded to fit precisely on the floor of each applicable RZR® model
- Mats keep the vehicle floor clean from dirt, mud, snow, debris and moisture
- Mats can be easily removed for cleaning; sprayed clean or hand-washed
- Mat design provides riders' feet with enhanced traction for the best foothold on the floor while riding

2880414 | Front Seat | 2 Mats

RZR® XP 1000 MY 14-15, RZR® 900 MY 15, RZR® S 900 MY 15, RZR® 900 XC MY 15

2880415 | Front and Rear Seats | 4 Mats

RZR® XP 4 1000 MY 14-15



3-PANEL REAR VIEW MIRROR

- Fully adjustable independent mirrors
- Mirror mounts at top of RZR® with two adjustable clamps
- Includes mirror and mounting hardware
- Powder-coated billet aluminum

2879527 | Black

ALL RZR® MODELS



REAR VIEW MIRROR

- Convex design delivers wide rear view
- Works with all roofs, soft tops and windshields

2877945

ALL RZR® MODELS



POLARIS® XTR GPS BY LOWRANCE®

- High-accuracy internal GPS satellite
- High-resolution, high-brightness Polaris® XTR and Mapping Accessories
- High-resolution, high-brightness 5" color display with user-adjustable backlight and night mode
- Built-in enhanced topographical basemap with 60' contour lines, tracks, waypoints and routes
- Waterproof and rugged
- Extended operating temperature range
- SD memory card slot for optional mapping add-ons, user data file transfers and software updates
- Multi-language support
- 2-year limited warranty

2879174

ALL RZR® MODELS

If you are installing this on a model that has or will have a metal roof, you will also need to purchase an NMEA 2000 compatible antenna (sold separately, not through Polaris®)

SOUTHWEST REGION HD MAP CARD (NOT SHOWN)

2879424

NORTHWEST REGION HD MAP CARD (NOT SHOWN)

2879425

NORTH CENTRAL REGION HD MAP CARD (NOT SHOWN)

2879426

SOUTH CENTRAL REGION HD MAP CARD (NOT SHOWN)

2879427

GREAT LAKES REGION HD MAP CARD (NOT SHOWN)

2879428

SOUTHEAST REGION HD MAP CARD (NOT SHOWN)

2879429

NORTHEAST REGION HD MAP CARD (NOT SHOWN)

2879430

GPS MOUNT

- Use this mount to securely install a Lowrance® XTR GPS into the dash of a RZR®

2879827

RZR® XP 1000 MY 14-15, RZR® 900 MY 15, RZR® S 900 MY 15

2879175 | RZR® 570 MY 12-15, RZR® 800 MY 08-14, RZR® 4 MY 10-14, RZR® 900 MY 11-14, RZR® 900 4 MY 12-14

GPS not included



Polaris®-Exclusive Highly Detailed Off-Road Mapping

PERFORMANCE

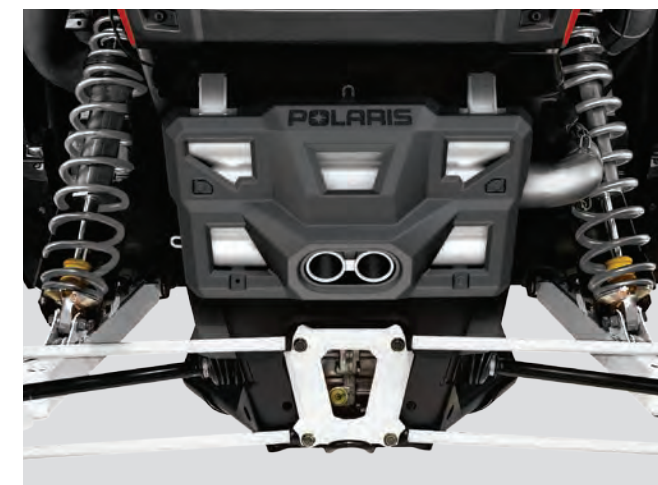

SLIP-ON EXHAUST **NEW**

- Performance-inspired style and rich, throatier exhaust note
- Polaris®-exclusive design gives the vehicle a unique custom look
- No intake or engine modifications required
- All hardware required for installation is included
- Stainless steel construction to withstand the high heat conditions

2879519

RZR® XP 1000 MY 14, RZR® XP 4 1000 MY 14

2880617

RZR® XP 1000 MY 15, RZR® XP 4 1000 MY 15



HIGH CLEARANCE A-ARM KIT **NEW**

- These High Clearance Front A-Arms feature a dual bend design supplying clearance from frame to the hub without adding a lift
- Retains stock suspension geometry to not affect driveline / suspension durability or performance
- Includes all new hardware including bushings and ball joints

2880796-458

RZR® XP 1000 MY 14-15, RZR® XP 4 1000 MY 14-15



HIGH CLEARANCE RADIUS RODS **NEW**

- These High Clearance Front A-Arms feature a dual bend design supplying clearance from frame to the hub without adding a lift
- Retains stock suspension geometry to not affect driveline / suspension durability or performance
- Includes all new hardware including bushings and ball joints
- Rear rods are increased in thickness and durability compared to stock rods

2879523-458

RZR® XP 1000 MY 14-15, RZR® XP 4 1000 MY 14-15

Does not fit with any version of Rear Bumper 2880560

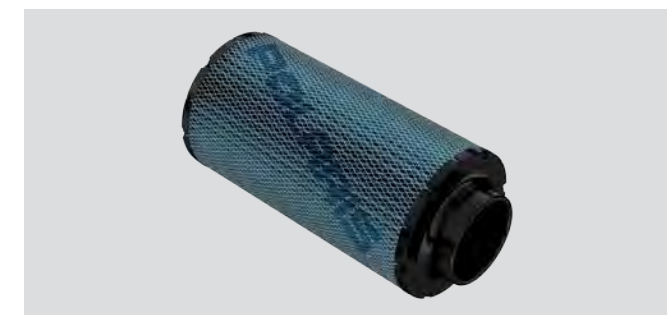

DONALDSON PREMIUM AIR FILTER KIT **NEW**

- The Polaris® RZR® XP 1000 high-performance air filter was co-developed by Polaris® and Donaldson to create the highest performing air filter for this vehicle. It uses Donaldson-exclusive Advanced Ultra-Web® Nanofiber Filtration Technology, which offers a higher initial efficiency compared with standard cellulose media and has very high efficiency throughout a filter's life.
- Best engine protection; 99.99% efficient.
- Superior dust-holding capacity; 20% increase in service life over the stock RZR® XP 1000 air filter
- Lower restriction over the life of the filter compared with the stock RZR® XP 1000 air filter
- Donaldson blue filters with Ultra-Web® Technology have been used in the dustiest conditions in the world, including many military vehicles and mining haul trucks







2879520

RZR® XP 1000 MY 14-15, RZR® XP 4 1000 MY 14-15

TIRES & WHEELS

STEP 1: CHOOSE YOUR TIRE

CHOOSE THE BEST TIRE FOR THE WAY YOU RIDE

 Trail patterns optimized for extreme traction Side walls tested for supreme durability Ideal for both hard pack and loose trail	 Flexible "grippy" tread Aggressive side bite
 Provides traction and durability Built to perform in sand, jagged rocks or any other extreme terrain	 Handles extreme cold Holds shape and provide traction
 Industry leading anti-puncture side walls Aggressive long lasting tread	 Extra deep treads Full wall side bite

STEP 2: CHOOSE YOUR WHEEL

									
HEXLR™ 15" FLAT BLACK BEADLOCK* 1522173-458 15" X 7" FRONT/REAR RZR® XP 1000 MY 14-15	HEXLR™ 15" TITANIUM BEADLOCK* 1522173-654 15" X 7" FRONT/REAR RZR® XP 1000 MY 14-15	REBLR™ 14" BEADLOCK** 1522238-458 14" X 7" FRONT 1522239-458 14" X 8" REAR ALL RZR® MODELS	VADER™ 14" LUSTER 1521992-410 14" X 7" FRONT 1521993-410 14" X 8" REAR ALL RZR® MODELS	VADER™ 14" 1521992-521 14" X 7" FRONT 1521993-521 14" X 8" REAR ALL RZR® MODELS	WREC™ 14" LUSTER 1521994-410 14" X 7" FRONT 1521995-410 14" X 8" REAR ALL RZR® MODELS	WREC™ 14" 1521994-521 14" X 7" FRONT 1521995-521 14" X 8" REAR ALL RZR® MODELS	SIXR™ 14" LUSTER 1521507-410 14" X 7" FRONT 1521508-410 14" X 8" REAR ALL RZR® MODELS	SIXR™ 14" 1521507-521 14" X 7" FRONT 1521508-521 14" X 8" REAR ALL RZR® MODELS	SIXR™ 14" MACHINED 1521507-266 14" X 7" FRONT 1521508-266 14" X 8" REAR ALL RZR® MODELS

STEP 3: ADD YOUR LUG NUTS



12 MM LUG NUT KITS

2879332 | Set of 16 | With Wrench

2879331 | Set of 4 | No Wrench

2204966 | 12 mm Lug Nut Wrench
RZR® 1000 ONLY

SAE® LUG NUTS FOR ALUMINUM WHEELS

2876754 | Set of 4

2877409 | Set of 16
ALL RZR® MODELS

STEP 4: ADD YOUR RINGS

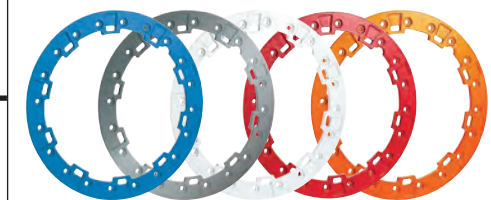

15" FORGE BILLET RINGS

1522240-619 | VooDoo Blue **NEW**

1522240-266 | Machined **NEW**

1522240-133 | White

1522240-293 | Indy Red

1522240-589 | Orange Crush
RZR® XP 1000 MY 14-15
15" beadlock wheels only

14" FORGE BILLET RINGS

1522244-266 | Machined **NEW**

1522244-133 | White

1522244-293 | Indy Red

1522244-589 | Orange Crush
ALL RZR® MODELS
14" beadlock wheels only

REPLACEMENT CAPS



CENTER CAPS

1522243-458 | Flat Black

1522243-654 | Titanium
Only fit HEXLR wheels

1521509-410 | Luster

1521509-521 | Flat Black
ALL RZR® MODELS
Fit all wheels except HEXLR

* Require 15" Stamped Forge Billet Rings: 1522240-133, 1522240-293, 1522240-589, 2522240-619 or 1522240-266

** Requires 14" Stamped Forge Billet Rings: 1522244-133, 1522244-293, 1522244-589 or 1522244-266

 	MOTO HAMMER 15" TIRES NEW Built using 8-ply Armor Belt® construction the 15" Moto Hammer is ready for race or recreation. With an aggressive tread pattern and deep side bite you will experience industry leading traction and performance in hard or soft-pack trails, mud, rocks and sand. Measuring 30" tall, the Moto Hammer is designed to maximize horsepower and propel your XP 1000 to the front. 5414979 30" X 9.5" X R15" FRONT AND REAR RZR® 1000		2880031	2880030															
 	MOTO CRAWLERS 14" TIRES NEW Engineered to provide unmatched grip the 30" Moto Crawler is built for the rocks. An aggressive tread pattern and 8-ply-rated Armor Belt® construction provide supreme performance and puncture resistance. Coupled with our 14" REBLR beadlock wheels, these can be aired down for heroic climbing performance. The same tire and wheel fits all 4 corners of your machine for even traction all-around, and it's a no-brainer what spare to bring (as if you'll need one). 5415250 30" X 10" X 14" FRONT AND REAR				2880674 Only available for REBLR™s*														
	MOTO MUD 14" TIRES NEW With 1.5" deep lugs and side paddles all the way to the wheel, the 27" Moto Mud will power your Polaris® ATV, Ranger® or RZR® through the muddiest conditions out there. Built using 8-ply-rated Armor Belt® construction these tires will churn through anything with authority. Bring a tow strap so your friends don't get left behind. 5415249 27" X 9" X 14" FRONT 5415368 27" X 11" X 14" REAR				2880693	2880694	2880695	2880696	2880697	2880698	2880699	2880700							
 	MOTO ATTACK 14" TIRES This 8-ply 14" Moto Attack Tire features advanced radial construction, aggressive deep tread and side-bite traction to provide a Polaris® ATV, RZR® or RANGER® rider with outstanding traction, handling and long-lasting durability. These tires are ready to race, haul and roll with great handling in deep mud trenches, gravel, hard- or soft-pack trails and sand. 5414980 26" X 9" FRONT 5414981 26" X 11" REAR				2880024	2880084	2880085	2880086	2880087	2880090	2880088	2880089							
	KANATI MONGREL® 15" TIRES This durable, 8-ply, high-traction 15" Kanati Mongrel® Tire provides a Polaris® RZR® XP 1000 rider or racer with great handling in hard-pack or soft-pack trail surfaces, gravel, mud and rocks. This is a true 30" tall tire, ready to race, rock-crawl or roll. 5415036 30" X 10" FRONT AND REAR		2880078 Only available for XP1000	2880079 Only available for XP1000															
	SEDONA™ RIPSAP 14" TIRES With its aggressive, 1½" deep treads, this 6-ply radial tire delivers outstanding performance on extreme terrain. Traction is excellent in deep ruts and in mud. 5413344 26" X 9" FRONT 5413345 26" X 11" REAR				2880025	2879292	2879296	2879300	2879304	2878882	2878884	2878886							
 	MAXXIS® BIGHORN® 14" TIRES The tread pattern and wide footprint give this 6-ply radial outstanding traction, and its shoulder lugs help protect the sidewalls. 2876905 26" X 9" FRONT 2876906 26" X 11" REAR				2880026	2879294	2879298	2879302	2879306	2878434	2878030	2878032							
	ITP® BAJA CROSS 14" TIRES 8-ply, extended-life rubber compound and innovative overlapping tread pattern provide a smooth, predictable ride and slow wear characteristics. 5414127 26" X 10" FRONT 5414120 26" X 11" REAR				2880027	2879295	2879299	2879303	2879307	2878432	2878435	2878437							
 	ITP® MUD LITE XTR 14" TIRES Aggressive tread design features 1½" deep, angled grooves for superior traction in trail or mud situations. 6-ply radial construction offers a smooth ride and long life. 5414674 27" X 9" FRONT 5414675 27" X 11" REAR				2880028	2879389	2879390	2879391	2879392	2879393	2879394	2879395							
	STI VORTEX V-ROLL 14" TIRES Lightweight 4-ply construction and super-wide profile provide added flotation to keep you on top of the sand. Low-profile sidewall and 8-paddle configuration keep you moving and keep your vehicle stable. 5414676 27" X 11" FRONT 5414677 27" X 14" REAR				2880029	2879398	2879399	2879400	2879401	2879402	2879403	2879404							

GLACIER® PRO PLOW SYSTEM

LOCK & RIDE



GLACIER® PRO PLOW

- Heavy-duty cast steel frame for maximum durability
- Lock & Ride® for easy blade installation and removal
- 66" W x 17" H heavy-duty blade
- Low-maintenance, self-contained electric over hydraulic cylinders
- Modular design lets you choose: Hydraulic or Winch Lift
- Choice of blade angle control: Hydraulic or Manual Angle
- Lift and angle adjustments can be made from the driver's seat
- Manual angle with shear pin design protects plow in high-impact contact
- Manual angle adjustment is easily accessible, prevents digging into snow to change angle
- Auto-retracting kickstand folds in as you drive away

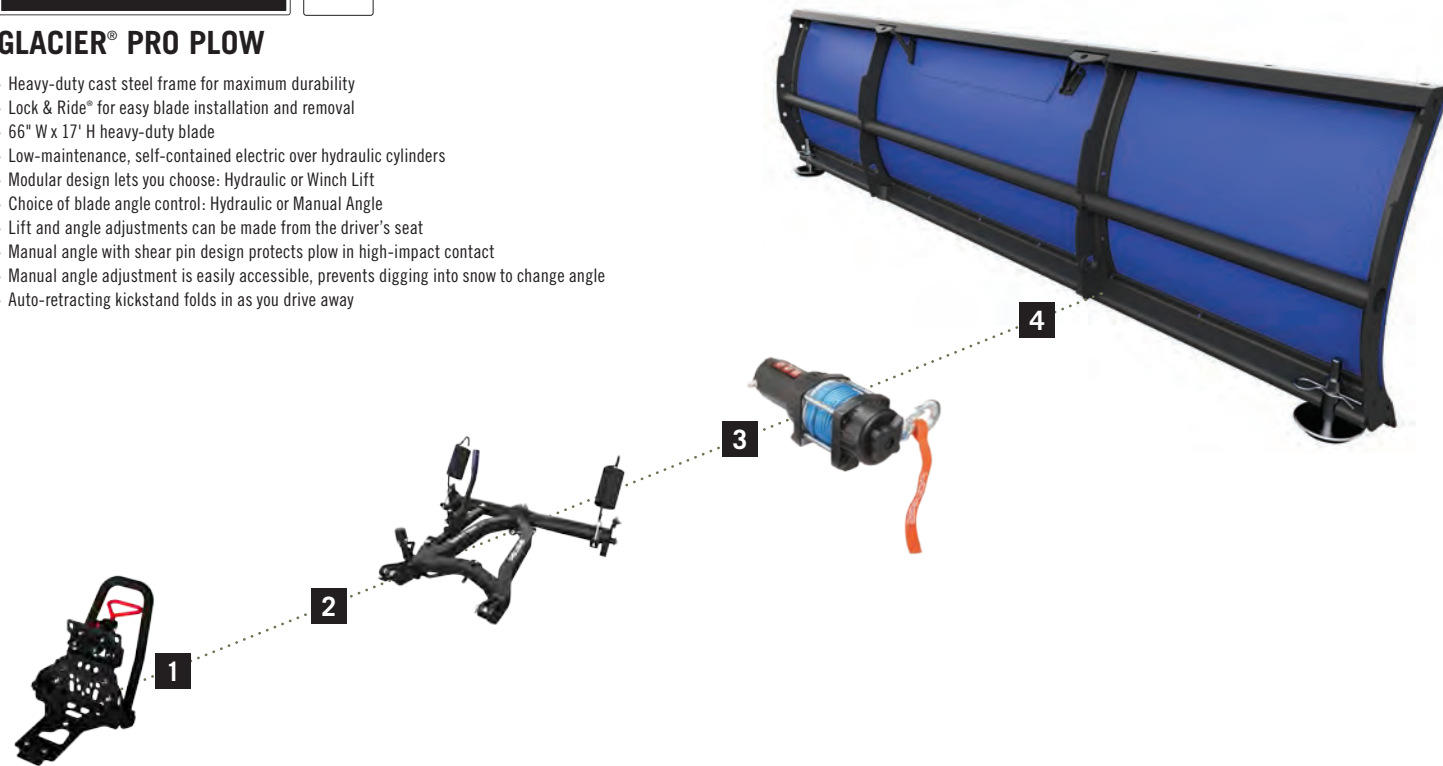

! Plow system does not work with tracks.

STEP 1: SELECT A MOUNT

- Strong, durable, reliable steel Plow Mount attaches securely to vehicle frame and is ready to accept a plow blade whenever it's time to plow
- Mount bolts securely under vehicle and can be left in place permanently, including when not plowing

GLACIER® 2 PLOW MOUNT

2878824
RZR® 570 MY 12-14, RZR® 800 MY 08-14, RZR® S MY 09-14

GLACIER® PRO PLOW MOUNT

2880262 **NEW**
RZR® 900 MY 15, RZR® S 900 MY 15, RZR® 900 XC MY 15

STEP 2: SELECT A FRAME

GLACIER® 2 PLOW FRAME

2878822
RZR® 570 MY 12-14, RZR® 800 MY 08-14, RZR® S MY 09-14

GLACIER® PRO PLOW FRAME

2880260 **NEW**
RZR® 900 MY 15, RZR® S 900 MY 15, RZR® 900 XC MY 15

STEP 3: CONFIGURE PLOW

SELECT A LIFT METHOD

POLARIS® PRO HD 4500 LB. WINCH
POLARIS® HD 3500 LB. WINCH
WARN® PROVANTAGE 3500 LB. WINCH
WARN® PROVANTAGE 4500 LB. WINCH
SEE PAGES 40-41

ADD AN ANGLE SYSTEM

GLACIER® PRO HYDRAULIC ANGLE SYSTEM **NEW**

- Heavy-duty hydraulic angle system adjusts the plow blade angle in a Glacier® PRO Plow System
- Angle the plow blade left or right with push-button ease to direct materials where desired
- No need to get out of cab to adjust plow blade
- Finish plowing jobs faster, more comfortably and with higher-quality results

2880266
RZR® 900 MY 15, RZR® S 900 MY 15, RZR® 900 XC MY 15
Requires a Power Controller (2880836)



SNO-GLIDE SERVICE PARTS:

SNO-GLIDE SKID SHOE (SOLD AS A SET)
2873423

REAR STEEL SUPPORT
2204624

OUTER WEAR BARS (SOLD AS A SET)
2204625

STEP 4: SELECT A BLADE

GLACIER® PRO 66" POLY BLADE

- Strong, durable, lightweight Poly Plow Blade is ideal for a wide range of residential driveway plow jobs
- Polyethylene snow blade flexes and absorbs impact so less impact energy and stress is transmitted to the machine while plowing
- 66"-wide blade has forward-angled corners and scoop design for increased plowing surface
- Poly blade can flex in all temperatures and will not rust like metal blades
- Includes a replaceable metal wear bar

2880269

GLACIER® PRO 66" STEEL BLADE

- Strong, durable steel construction ensures this plow blade will tackle big jobs season after season
- With impressive, 66" span, blade moves large quantities of material with each pass
- Comes with replaceable metal wear bar

2880268

GLACIER® 2 PLOW BLADES:

66" SNO-GLIDE BLADE

2878686
Recommended for standard RZR®. Due to height and angle, blade will not work with RZR® S.

60" RAZOR BLADE® TWO-WAY

2875370

60" SNOW BLADE

2876626

52" SNOW BLADE

2876627

CHOOSE THE RIGHT BLADE

Select the plow blade that's right for the way you plow.

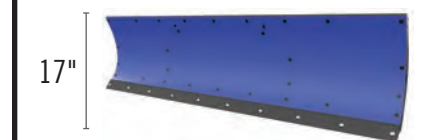

66" POLY BLADE
Best for impact absorption



66" STEEL BLADE
Best for big jobs year after year

POLARIS®

ENGINEERED PARTS
ACCESSORIES & APPAREL

**Prospector
PRO** TRACK SYSTEM

TRACKS

WHEN YOU'RE SEEING MORE SNOW THAN SAND, A PROSPECTOR PRO® TRACK SYSTEM IS THE PERFECT WAY TO OPTIMIZE YOUR RZR®. A TRACK SYSTEM WILL LET YOU FULLY UTILIZE YOUR ON-DEMAND TRUE ALL-WHEEL DRIVE AND MAKE SLEDGING THROUGH SNOW AS EASY AS DRIVING ON A PAVED ROAD.

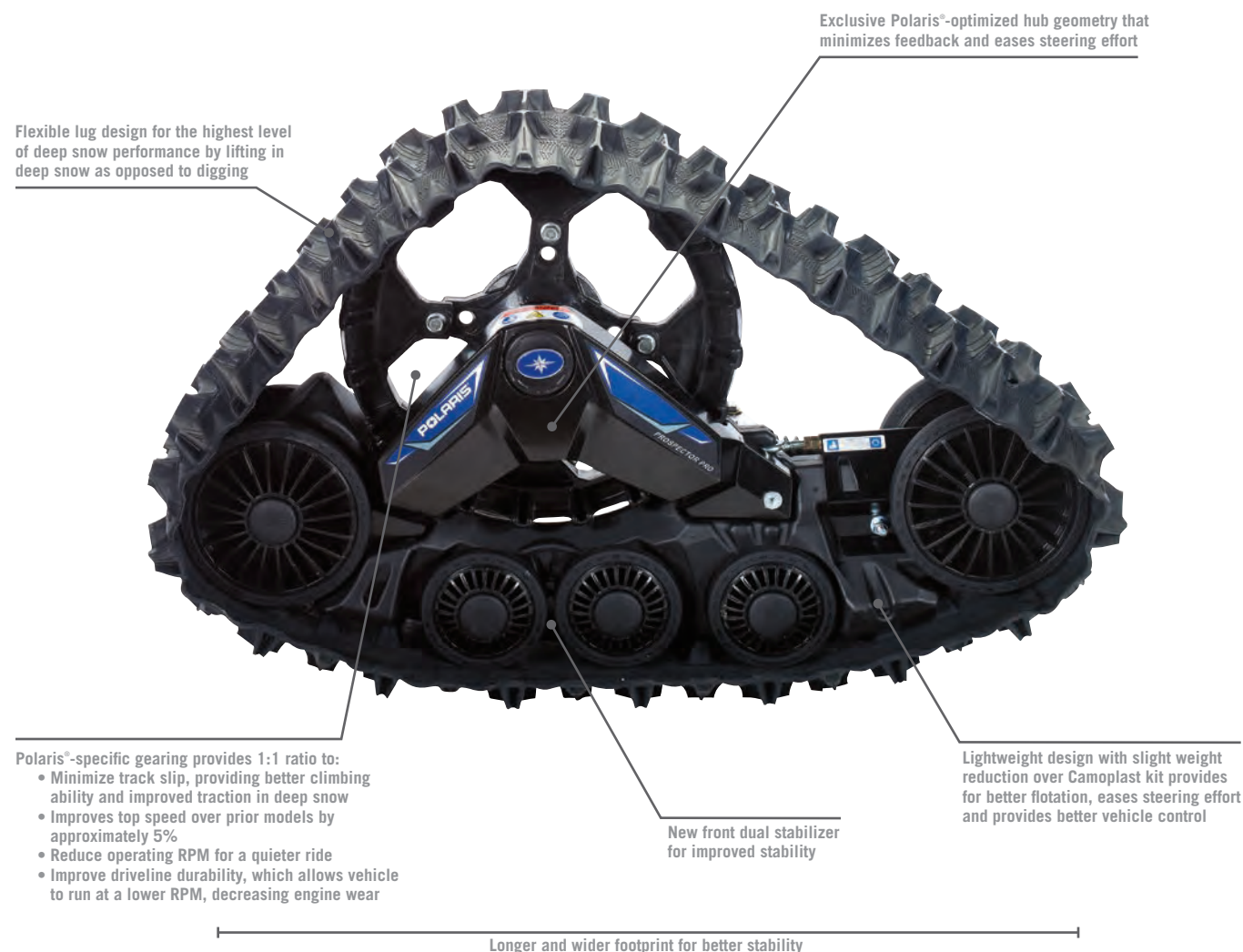

STEP 1: SELECT A MOUNT

RZR® PROSPECTOR MOUNTS

2880648 **NEW**
RZR® S 900 MY 15, RZR® 900 XC MY 15

2880649 **NEW**
RZR® S 900 MY 15

2879453
RZR® 800 MODELS MY 08-14

2879749
RZR® S MODELS MY 09-14

2879750
RZR® 570 MODELS MY 12-14 ONLY

STEP 2: SELECT A KIT

TRACKS PROSPECTOR PRO®, UTV

- Polaris® Prospector Pro® Track systems are designed, engineered and built specifically for Polaris® side-by-sides
- They deliver the best in performance, reliability and durability in all four seasons
- This track system's mounting hardware, drive system gearing and track design are all engineered and built specifically for the Polaris® side-by-sides
- Polaris® track systems deliver the utmost in performance and productivity

2880758
RZR® 900 MY 15, RZR® S 900 MY 15, RZR® 900 XC MY 15 EPS MODELS ONLY

2880757
RZR® 900 MY 15, RZR® S 900 MY 15, RZR® 900 XC MY 15 NON-EPS MODELS ONLY AND RZR® 570 MY 12-15, RZR® 800 MY 08-14, RZR® S MY 09-14

POLARIS®

ENGINEERED PARTS
ACCESSORIES & APPAREL

YOUTH/RZR® 170



RZR® 170 SKID PLATE

- 3-piece construction for full coverage
- Extends full length of undercarriage
- Tough, durable .20"-thick polyethylene

2878343
RZR® 170 MY 09-13
2880075
RZR® 170 MY 14



RZR® 170 BIG WHEEL KIT

- Front 22" x 7" x 10" (55.9 x 17.8 x 25.4 cm) Duro Blackhawk Tires
- Rear 22" x 10" x 10" (55.9 x 25.4 x 25.4 cm) Duro Blackhawk Tires
- Two 10" x 5" (25.4 x 12.7 cm) Spun Aluminum Wheels
- Two 10" x 8" (25.4 x 20.3 cm) Spun Aluminum Wheels

2880074
RZR® 170 MY 09-14

RZR® 170 SPROCKET UPGRADE KIT (NOT SHOWN)

- 15T front and 36T rear sprockets with a 520 O-ring chain

2880073
RZR® 170 MY 09-14



RZR® 170 HALF WINDSHIELD

- Provides protection from rain, debris, branches
- Installs easily and securely
- Retains open-air riding environment
- Adds sporty style

2877813
RZR® 170 MY 09-14



RZR® 170 FRONT BRUSHGUARD

- Strong, tough and protective
- Protects front end of vehicle from impact
- Styling and finish complement vehicle's sporty look
- Easy bolt-on installation

2877813
RZR® 170 MY 09-14



RZR® 170 SOFT TOP

- Adds sporty styling and offers protection
- Provides shade for riders
- Protects against rain and overhead branches, etc.
- Easy installation

2877685
RZR® 170 MY 09-14

LUBRICANTS & VEHICLE CARE

POLARIS ENGINEERED™ LUBRICANTS ARE ENGINEER APPROVED, DESIGNED AND TESTED TO MEET THE NEEDS OF YOUR POLARIS® HIGH-PERFORMANCE 4-STROKE ENGINE.



EXTENDED LIFE ANTI-FREEZE 50/50 FORMULATION **NEW**

- Extended 5-year service interval
- New organic acid technology
- Hard water compatible
- No scaling = better heat transfer
- New yellow coloration

2880514 | 1 US Quart | 12 per case

2880513 | 1 US Gallon | 6 per case

2880512 | 55 US Gallon Drum

AGL PLUS

- Full synthetic friction-reducing formulation, extreme pressure film protection for severe operating temperatures
- Prevents rust, oxidation, foam and corrosion of internal ATV transmission components

2878068 | Quart | 12 per case

2878069 | Gallon | 6 per case

2878070 | 2.5 Gallon | 2 per case

2879594 | 55 Gallon

DEMAND DRIVE PLUS

- Formulated for lubricity, corrosion and oxidation protection in all operating conditions
- Replaces Demand Drive Fluid, LT Demand Drive Fluid, and ADC Fluid

2877922 | Quart | 12 per case

2877923 | 2.5 Gallon | 2 per case

ATV ANGLE DRIVE FLUID

2876160 | Quart | 12 per case

2872276 | 2.5 Gallon | 2 per case

ALL-SEASON GREASE

- Low-temperature pliability for protection at cold start-up as well as excellent high-speed and high-temperature protection

2871322 | 3 oz. 4-pack | 6 per case

2871423 | 14 oz. | 10 per case

2871312 | Grease Gun Kit | 4 per case

U-JOINT GREASE

2871515 | 3 oz 4-pack | 24 per case

2871551 | 14 oz | 10 per case

SYNTHETIC DIESEL ENGINE OIL **NEW**

- All-Season 5W-40 Formula
- Excellent cold weather protection
- Ultimate protection in severe duty applications

2879832 | Quart | 12 per case

SUMMER 15W40 DIESEL OIL

- Multi grade lubricant designed for heavy duty equipment
- Excellent wear protection during high temperature applications

2878473 | 2 Quart Bottle | 8 per case

2878471 | Oil Change Kit | 4 per case

CARBON CLEAN FUEL TREATMENT

- Dissolves gum and varnish in fuel system
- Prevents and cleans carbon in combustion chamber
- Excellent fuel stabilizer for storage
- Formulated for both 2- and 4-cycle engines
- Absorbs water and stabilizes fuel

2871326 | 12 oz. | 12 per case

PREMIUM ETHANOL FUEL STABILIZER

- Prevents fuel oxidation and system corrosion
- Significantly reduces gum and varnish formation
- Protects fuel system components
- Formulated for both 2- and 4-cycle engines

2870652 | Quart | 12 per case

2872280 | 2.5 Gallon | 2 per case



PS-4 OIL CHANGE KITS

2202166 | Sportsman ACE™ 570, RZR®/Ranger® 570, Twin 600, 700, 800

2877473 | Sportsman™ 330-570, XP 550/850/1000

2880913 | Sportsman® ETX, Sportsman ACE™, Ranger® ETX

2879129 | RZR® XP 2011-2012

2879323 | Ranger® 900 / RZR® 900, 1000



PS-4 EXTREME DUTY OIL CHANGE KITS

2879004 | Sportsman ACE™ 570, RZR®/Ranger® 570, Twin 600, 700, 800

2878924 | Sportsman™ 330-570, XP 550/850/1000

2879130 | RZR® XP 2011-2012

2879324 | Ranger® 900/RZR® 900, 1000



ORV MAINTENANCE KIT

- Kit includes:
 - 1.5 quarts of AGL
 - 1 quart of Angle Drive Fluid
 - 1 pint of Demand Drive Fluid
 - 1 3oz. tube of All-Season Grease
- Services all ATV, Rangers, and RZR's

2888471



PS-4 EXTREME DUTY ENGINE OIL

- Ultimate high-temperature engine protection
- Prevents thermal breakdown
- Maximum rust and corrosion protection
- Designed for professional grade and high-temp 4-cycle applications

2878920 | Quart (12 per case)

2878922 | 2 Quart (8 per case)

2878919 | Gallon (4 per case)

2879003 | 16 Gallon

2879002 | 55 Gallon

2879001 | 330 Gallon Tote



PS-4 SYNTHETIC ENGINE OIL

- Maximum engine protection in cold and hot conditions
- Easy starting in extreme cold
- Extra rust and corrosion protection
- Extends gear and clutch life
- Designed specifically for Polaris® 4-cycle engines

2876244 | Quart | 12 per case

2877490 | 2 Quart | 8 per case

2876245 | Gallon | 4 per case

2876247 | 16 Gallon

2876246 | 55 Gallon

2878814 | 330 Gallon Tote



XP WASH™ **NEW**

- Removed the most intense and stubborn dirt and trail build up easily
- A foaming, highly concentrated wash
- Superior water beading

2830203

XP SPRAY WASH™ **NEW**

- Effortless cleaning power – simply spray on, spray off and go
- A biodegradable, high-performance wash ideal for removing dirt, oils and carbon build up

2830202

POLARIS® POLISH **NEW**

- Protection and shine have never looked so good or been so easy – spray on, wipe off and go
- Ideal on painted and plastic surfaces
- Contains carnauba wax

2830207

NEVER RUST SPRAY **NEW**

- Brutal conditions demand superior protection, be prepared for any climate before and after you ride
- Synthetic formula protects against rust and corrosion while lubricating metal surfaces
- High resistance to water wash out

2830209

INSTANT SHINE & DETAILER **NEW**

- Cleans, polishes and protects plastic and painted surfaces
- Be quick, be effective, be ready to go
- Spray and wipe formula

2830204

ALL PURPOSE CLEANER **NEW**

- Biodegradable formula removes dirt and grime effortlessly
- Use on netting, seats, wheels, tires, plastic, and metal surfaces

2830205

MUD SHIELD™ PRE TREATMENT **NEW**

- Pre-treat and protect, engineered for the most extreme conditions
- Makes cleaning your vehicle easier and faster
- Inhibits the adhesion of dirt, mud and snow

2830208

* Extreme Cold Extreme Hot *

← PS-4 Extreme Duty →

← PS-4 →

-40F/-40C 0F/-20C 100F/40C 130F/55C

< EXTREME COLD EASY START

EXTREME HEAT WEAR PROTECTION >

MAINTENANCE PARTS

POLARIS ENGINEERED™ PARTS ARE DESIGNED AND ENGINEERED TO OPTIMIZE YOUR VEHICLE'S PERFORMANCE AND DELIVER THE TRUE HIGH-PERFORMANCE YOU DEMAND.



ORV AIR FILTERS

- 99.9% efficient in blocking dirt in extreme testing
- Superior filter capacity: Traps 32% more contaminants than the closest competitor
- Costs half as much as compared to leading aftermarket brands



ORV OIL FILTERS

- The Polaris® filter (#2540086) traps particles 64% smaller in size than the competition, resulting in lower levels of contamination in your engine
- The Polaris® filter has 44% less restriction than the competition to ensure adequate lubrication in all conditions



ORV BATTERIES

- We use only the highest quality batteries
- Engineered and tested to fit and perform on our machines



ORV BRAKE PADS

- High performance in any temperature and condition: wet, dry or mud
- Designed with the same material used by high-end motorcycles



ORV DRIVE BELTS

- Lowest tolerances (.188") provide highest performance
- The Polaris® Kevlar® belt provides 2x longer belt life than the competitor's "Heavy-Duty" belt

VEHICLE MODEL	AIR FILTER	BELT	OIL FILTER	BATTERY	BRAKE PAD FRONT	BRAKE PAD REAR
RZR® 570	7081706	3211143	2540086	4012622	2202413	2202413
RZR® 570 EPS	7081706	3211143	2540086	4010630	2203318	2202412
RZR® 900	7081889	3211148	2540086	4011224	2202413	2202413
RZR® 900 EPS	7081937	3211172	2540086	4014132-P	1911085	2203318
RZR® 900 XC Edition	7081937	3211172	2540086	4014132-P	1911085	2203318
RZR® S 900	7081937	3211172	2540086	4014132-P	1911085	2203318
RZR® S 900 EPS	7081937	3211172	2540086	4014132-P	1911085	2203318
RZR® XP 1000 EPS	7081864	3211148	2540086	4014132-P	2203747	2203747
RZR® XP 4 1000 EPS	1240822	3211148	2540086	4014132-P	2203747	2203747

All models listed are MY 15. For past models, please visit <http://www.polaris.com/en-us/atv-ranger-rzr/parts-manuals>

FIT CHARTS

1. GO TO THE "DEALER EXTRANET."
2. UNDER "NEWS, FORMS AND LINKS" CLICK ON "PURE POLARIS."
3. FIND THE REFERENCE AND FITMENT CHART FOR YOUR VEHICLE.

REFERENCE MANUALS

1. GO TO THE "DEALER EXTRANET."
2. UNDER "NEWS, FORMS AND LINKS" CLICK ON "TECHNICAL PARTS."
3. FIND THE QUICK REFERENCE MANUAL FOR YOUR VEHICLE.

TRAILERS & ACCESSORIES



STEEL UTILITY CART — TANDEM AXLE

- Tandem, sealed-bearing axle design; articulating center pivot provides reliable travel over rough terrain
- Designed to military specifications; military-tested and proven
- Cart has a 1000-lb. (453.6kg) payload capacity
- Holds up to 17 cu. ft. (5.2 cu. m) of heaping material such as brush
- Drop-down tailgate for easy loading and dumping
- Pin hitch
- Rolls on 18" x 9.5" x 8" (45.7 x 24.13 x 20.3 cm) off-road tires
- Overall size 60.9" x 35.1" x 12"
- Interior size 57.7" x 31.7" x 12"

2878231



TRAILER BALL AND SHANK

- Locks draw bar to ATV

2877602 | 1 1/2" trailer ball, 3/4" shank

2877603 | 2" trailer ball, 3/4" shank

DROP RECEIVER HITCH DRAW BAR

2877638



STRAPS, RED RATCHET

2859047-01

STRAPS, BLACK RATCHET

2859047-02

STRAPS, 5' BLACK TIE DOWN

2871181

STRAPS, 5' RED TIE DOWN

2871182



ENCLOSED TRAILERS

The Polaris® brand of enclosed trailers is the ultimate combination of quality, style and versatility. With a variety of sizes and price points to choose from, this brand is among the most diverse in the industry. Introducing the market's first "Side By Side"™ UTV package, we've revolutionized the way you'll tow, and store, your Polaris® machines.

Standard features include all-aluminum box-tube framework, .030" exterior side panels and torsion ride axles. Box lengths range from 8' to 20'.

PG6.5X16 QUICK SPECS

Payload Capacity:	4325#
Interior Dim (LxWxH):	15' 10" x 77" x 76"
Overall Dim (LxWxH):	21' 7" x 101" x 8' 1"
Axles:	(2) 3500# Braked
Wheels/Tires:	15" White Mod / 205/75D15
GVWR:	6000#

OPEN TRAILERS

Our *RANGER*™ 12 utility trailer was custom designed around the world-famous line of Polaris® utility vehicles. Built from all-aluminum framework, 5/4" pressure-treated decking boards and the highest quality components available, the *RANGER*™ 12 is rugged enough to withstand the best that you, or Mother Nature, can throw at it.

Polaris® utility trailer models range from 4' x 8' to 6.5' x 12', and are available in wood or aluminum decking. Popular options include bi-folding rear ramps, removable rail kits, diamond plate side panels, wheel jacks and D-ring tie-downs.

PATV 83X14 QUICK SPECS

Payload Capacity:	2565#
Deck Dim (LxW):	168" X 83"
Overall Dim (LxW):	18' X 102"
Axles:	(1) 3500# Idler (Leaf)
Wheels/Tires:	15" Silver Mod / 205/75D15
GVWR:	2990#



Model: RANGER 12



Model: PU 6.5x12-A

FOR MORE INFO, PLEASE VISIT:
WWW.POLARIS-TRAILERS.COM

Polaris® and its vehicle body designs and names are registered trademarks of Polaris® Industries Inc. Used under license. Polaris® designs, engineers, manufactures and markets snowmobiles, all-terrain vehicles (ATVs), Victory® motorcycles and the Polaris® *RANGER*™ for recreational and utility use. Information about the complete line of Polaris® products, apparel and vehicle accessories is available from authorized Polaris® dealers or anytime from the Polaris® homepage at www.polarisindustries.com.

RAMPS & COVERS

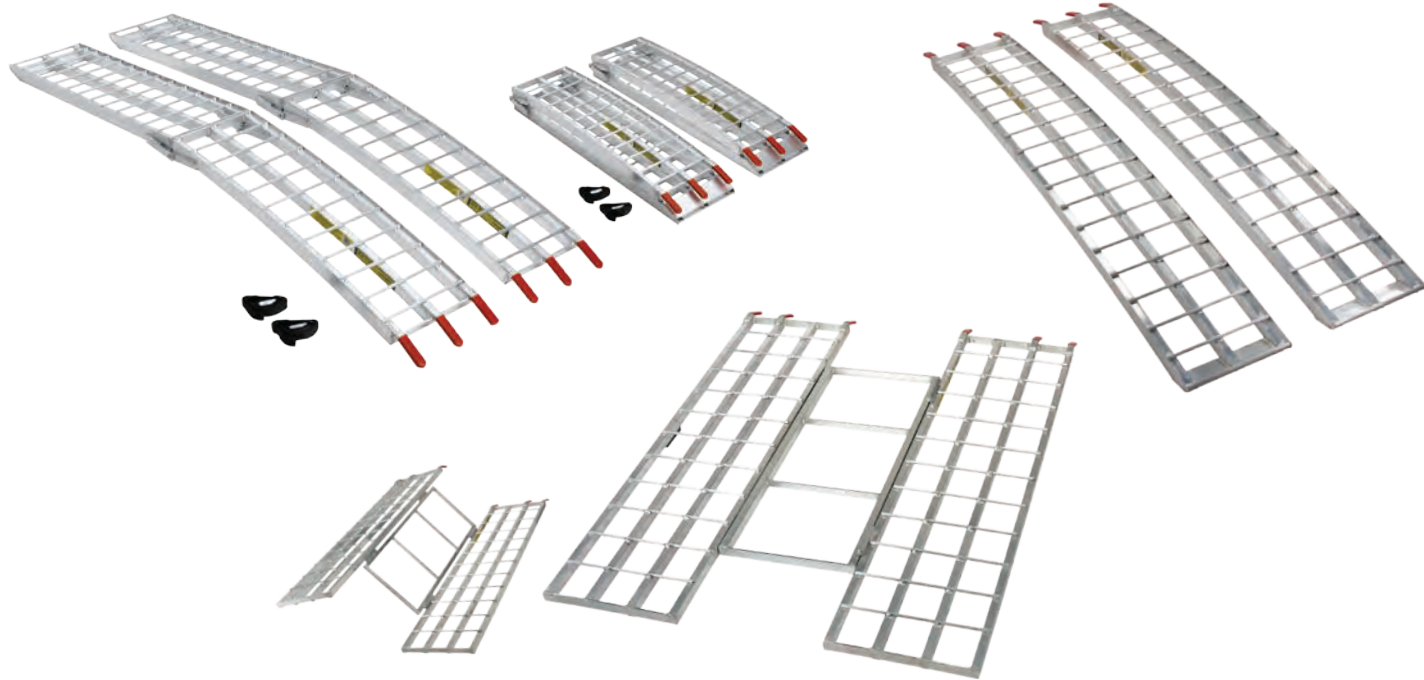

FOLDING HEAVY-DUTY ALUMINUM ARCHED RAMPS

- Fold up for transport
- Strong enough to hold up to 1,500 lb. (680.7 kg)
- Include safety straps and instructions
- Sold in pairs

2875387

LIGHTWEIGHT TRI-FOLD RAMP

- Handles up to 1,500 lb. (680.7 kg)
- Folds up to fit under ATV during transport
- Includes safety straps and instructions

2875385 | 72" x 51"

2875860 | 82" x 51"

ALUMINUM ARCHED LOADING RAMPS

- Each ramp measures 76" x 12" (23.2 x 30.5 cm)
- Combined capacity up to 2,000 lb. (907.2 kg)
- Easily transportable
- Sold in pairs

2875384

TRAILERABLE COVER

- Strong, durable, weatherproof canvas construction
- Canvas is UV-stable to resist fading from prolonged exposure to sunlight
- Designed specifically for your RZR® so it goes on and off easily, fits properly, and offers reliable, full-coverage protection
- Ratchet strap system on the bottom secures the cover to the vehicle
- Cover features expandable pockets that ensure coverage of vehicle, including all bumper systems, roof, most rear cargo box accessories and more
- Designed for forward trailering only

2879373 | Black
RZR® XP 1000 MY 14-15

2879949
RZR® XP 4 1000 MY 14-15

2880325 **NEW**
RZR® 900 MY 15

2880327 **NEW**
RZR® S 900 MY 15, RZR® 900 XC MY 15

2876526
RZR® 570 MY 12-14, RZR® 800 MY 08-14



HERITAGE

VISIT POLARIS.COM TO LEARN MORE

Category	Product Name	PN	Price	Fitment
Comfort & Electronics	Heater Kit	2878135		RZR® 800 MY 08-10, RZR® S MY 09-10, RZR® 4 MY 11 (Does not fit EPS models.)
Comfort & Electronics	Lock & Ride® Clamp Kit	2878747		ALL RZR® MODELS
Comfort & Electronics	Adjustable Aluminum Billet Clamps	2878798		ALL RZR® MODELS EXCEPT RZR® XP 1000
Storage	Lock & Ride® Tall Mountable Dry Storage Box	2879342		ALL RZR® MODELS
Storage	Bed Box Extender Kit	2878272		RZR® 800 MY 08-11, RZR® S MY 09-14, RZR® 4 MY 10-14
Storage	Lock & Ride® Under Hood Dry Storage Box	2879287		RZR® 570 MY 12-14, RZR® 800 MY 08-14, RZR® S MY 09-14, RZR® 4 MY 10-14
Storage	Lock & Ride® Mountable Dry Storage Box	2879185		ALL RZR® MODELS
Covers	RZR® Trailing Cover	2877321		RZR® S MY 09-14
Doors	Canvas Cab	2879818		RZR® 4 MY 10-14, RZR® 900 4 MY 12-14
Rear Panel	Canvas Rear Panel	2877411		RZR® 570 MY 12-14, RZR® 800 MY 08-14, RZR® S MY 09-14, RZR® 900 MY 11-14
Lighting	Fast Clamp	2858880		All RZR® Models Except RZR® XP 1000
Roof	RZR® 4 Canvas Roof	2878102		RZR® 4 MY 10-14, RZR® 900 4 MY 12-14
Cover	Trailable Cover	2878540		RZR® 900 MY 11-14
Comfort & Electronics	Heater Kit	2878366		RZR® 800 MY 11-14, RZR® S MY 11-14, RZR® 4 MY 11-14

POLARIS®

ENGINEERED PARTS
ACCESSORIES & APPAREL

HELMETS

WEARING A HELMET WHEN YOU RIDE IS JUST AS IMPORTANT AS REMEMBERING YOUR KEYS. THANKS TO POLARIS® INNOVATION, YOU CAN STILL LOOK GOOD WHILE PROTECTING YOUR HEAD AND YOUR LIFE.



FLY® F2

- Composite construction shell made of aircraft-grade woven carbon fiber and Kevlar® composite materials for superior, lightweight strength
- Dual-density EPS liner for impact absorption
- Multi-port air induction cooling system with tri-vent goggle anti-fog vents
- Removable washable liner and cheek pads
- Snell® M2010-, DOT- and ECE-approved

- 2865110 | Sly | XS-5XL
- 2865111 | Podium | XS-5XL
- 2865112 | Dominate | XS-5XL
- 2864218 | Black/VooDoo Blue | XS-2XL
- 2864208 | Black/Hi-Vis Yellow | XS-2XL
- 2863185 | Platinum Ice | XS-2XL

FLY F2® HELMET REPLACEMENT PARTS

- 2863165 | Breath Deflector
- 2864211 | Replacement Visor | Black/Hi-Vis
- 2864357 | Replacement Visor | Black/VooDoo Blue
- 2863202 | Replacement Visor | Race Orange
- 2863162 | Visor Screw Kit
- 286316401 | Cold Weather Plug Kit | XS/S
- 286316403 | Cold Weather Plug Kit | M/L
- 286316409 | Cold Weather Plug Kit | XL/2XL
- 2863199 | Cheek Pad | 40mm | XS
- 2863198 | Cheek Pad | 35mm | S, M, L
- 2863197 | Cheek Pad | 30mm | XL
- 2863196 | Cheek Pad | 25mm | 2XL
- 2863195 | Cheek Pad | 20mm | 3XL



Sly



Podium



Dominate



Black/VooDoo Blue



Black/Hi-Vis Yellow



Platinum Ice



Black Gloss

KTP HELMET

The unique, multi-purpose KTP features a face shield that slides up and down. It even works with goggles in the shield-up position.

- ABS thermo-injected shell
- Air-intake, flow-through ventilation system
- Fully removable, washable liner
- Adjustable visor, adjustable chin strap, movable polycarbonate eye shield replaces need for goggles
- DOT approved

- 2869364 | Black Gloss | S-2X



RZ MASK

- 286224203 | Black | Regular
- 286224206 | Black | XL

- 2863189 | Large Replacement Filters | OSFM | 3 per pack

- 2863190 | X-Large Replacement Filters | OSFM | 3 per pack

DEMON 1.1 HELMET

- Lightweight, protective composite fiberglass shell
- Dual-density EPS liner for impact absorption
- Aerodynamic, multi-channel flow-through ventilation system
- Moisture-wicking QwickDry® removable, washable liner
- Snell® M2010 and DOT-approved

- 2864179 | Assault | S-3X
- 2864176 | Red Gloss | S-3X
- 2864177 | Orange Gloss | S-3X
- 2864178 | Silver Gloss | S-3X

REPLACEMENT VISOR

- 2864186 | Red Gloss
- 2864187 | Orange Gloss
- 2864188 | Silver Gloss
- 2864189 | Assault® Matte

DEMON REPLACEMENT PARTS

- 2861233 | Breath Deflector
- 2869484 | Visor Screw Kit



Red Gloss



Orange Gloss



Silver Gloss



Assault® Special Edition

TENACITY HELMET

- Lightweight polycarbonate shell
- Mouth air-intake vent, eyebrow vents and six rear vents
- Removable, washable liner
- DOT/ECE-approved

- 2864180 | Red Gloss | S-2X
- 2860144 | Black Matte | S-2X
- 2864183 | Retro Gloss | S-3X
- 2864181 | Magenta Gloss | S-2X

TENACITY REPLACEMENT VISOR

- 2864190 | Red Gloss
- 2864191 | Magenta Gloss
- 2864193 | Black Matte
- 2862120 | Visor Screw Kit



Black Matte



Red Gloss



Magenta Gloss



White Gloss



Retro Gloss

POLARIS®

ENGINEERED PARTS
ACCESSORIES & APPAREL

GOGGLES

KEEP DEBRIS OUT SO YOU CAN KEEP YOUR EYES WHERE THEY BELONG - ON THE TRAIL. POLARIS®-EXCLUSIVE GOGGLES ARE DESIGNED WITH YOUR RIDE IN MIND SO YOUR LOOK CAN BE MORE INTEGRATED FROM VISOR TO VEHICLE.

509® FOR POLARIS®

509® DIRT PRO GOGGLES

509® for Polaris® goggles are loaded with performance-driven innovations for avid riders who insist on the best eye protection. These goggles provide the ultimate combination of protection, comfort, ventilation, tear-off compatibility and style.

Size: Oversized frame and lens fit inside all standard moto helmets' goggle port and provide broad visibility.

Lens: Protective, shatterproof, single-pane chrome lens; non-vented dirt lens has a durable anti-scratch and anti-fog coating; blocks 100% of UV rays and is easily interchangeable with accessory lenses.

Strap: Innovative hinged-strap mount allows the goggles to remain flush against the face for optimized protection and comfort; ensures that the goggles form a seal against the face to block dirt, dust and wind; adjustable, silicon-backed strap remains securely in place where positioned on helmet.

Foam: Triple-layer foam construction consists of 3 layers of moisture-wicking foam of varying densities for a comfortable fit on the face.

Tear-Off Compatible: Unique triple tear-off post design includes 2 posts on the lens and a third adjustable post attached to the strap for enhanced tear-off installation and removal.

Nose Guard: Rigid, vented nose guard protects nose and can be installed or removed in seconds.

Ventilation: 13-port vent system (7 on top, 7 at base of frame) promotes fresh air circulation for comfort and fog prevention.

A. 2864327 | Carbon Blue (chrome lens) | OSFM

B. 2863427 | Signature Red (chrome lens) | OSFM

C. 2864328 | Carbon Yellow (chrome lens) | OSFM

D. 2863426 | Signature Black (chrome lens) | OSFM

E. 2863429 | Blockade Orange (chrome lens) | OSFM

F. 2863428 | Blockade Black (chrome lens) | OSFM

509® DIRT PRO REPLACEMENT LENSES

2863430 | Chrome | OSFM

2863431 | Clear | OSFM

2863432 | Brown Polarized | OSFM

2863433 | Tear-Offs | 6 per pack | OSFM | \$5.49 CAN



POLARIS® TRAIL GOGGLES

2863434 | Black | OSFM

POLARIS® TRAIL GOGGLES REPLACEMENT LENS

2863482 | Clear | OSFM



POLARIS®

ENGINEERED PARTS
ACCESSORIES & APPAREL

GLOVES

GRIP UP AND GO. POLARIS® GLOVES ARE THE PERFECT MIX OF LIGHTWEIGHT COMFORT AND ENGINEERED DURABILITY FOR A PERFECT FIT AND FUNCTION.



FLY GLOVE

These lightweight gloves from the FLY Racing® for Polaris® Collection deliver outstanding protection and a sure grip while keeping hands comfortable.

Shell: Lycra® back panels stretch to provide a comfortable fit and are complemented by the embossed neoprene flex-knuckle system designed for protection and flexibility.

PALM: Lightly padded palm for extra comfort; durable construction with a reinforced thumb.

Additional Features: Soft-Flex TPR (thermoplastic rubber) graphics offer extra protection; adjustable TPR wrist closure system; silicone finger grippers for increased grip and control.

A. 2864209 | Black/Hi-Vis Yellow | S-3X

B. 2864219 | Black/VooDoo Blue | S-3X

C. 2863194 | Platinum Ice | S-3X

POLARIS®

ENGINEERED PARTS
ACCESSORIES & APPAREL

OGIO® BAGS

OGIO® BAGS FOR POLARIS® ARE HIGH-PERFORMANCE CARGO CARRIERS. BALLISTIC-GRADE MATERIALS AND EXCLUSIVE BRANDING GIVE YOU MORE FOR YOUR ON AND OFF ROAD JOURNEYS.

A. OGIO® RIG 9800 BAG

2864212 | Subtle Stripe



B. OGIO® 8800 TRUCKER

2864213 | Subtle Stripe



C. OGIO® LOADER 7600

2864214 | Subtle Stripe



D. ENDURANCE DUFFLE

2864215 | Subtle Stripe



E. BANDIT BACKPACK

2864216 | Subtle Stripe



F. WATERPROOF BACKPACK

2864217 | Charcoal Gray



POLARIS®

ENGINEERED PARTS
ACCESSORIES & APPAREL

JERSEYS

FLY RACING® JERSEYS

Developed by avid off-road riders, this lightweight, colorful jersey from the FLY Racing® for Polaris® Collection features materials and construction that promote airflow to keep an active rider cool and comfortable.

Fabric: Lightweight 100% polyester panels combine with mesh ventilation panels in key areas to promote airflow and dissipate body heat.

Graphics: Vibrant, permanent sublimated graphics, including Polaris® and FLY Racing® branding.

Additional Features: Low-profile, multi-directional Lycra® stretch collar; non-restrictive shorty cuffs with elastic sleeves help reduce arm pump; extended tail helps keep jersey tucked into pants; tagless printed collar eliminates tag irritation.

2864210 | Black/Hi-Vis Yellow | S-3X

2864220 | Black/VooDoo Blue | S-3X



BASE LAYERS

U.P. BASE LAYER

• 93% polyester and 7% spandex jersey knit
• Reflective logos

2864030 | Top | Grey | S-3XL

2864031 | Bottom | Grey | S-3XL

BLACK ICE BASE LAYER

• 93% polyester and 7% spandex jersey knit
• Contrast stitching, reflective logos

2864033 | Top | Black | S-3XL

2864032 | Bottom | Black | S-3XL



TECH WEAR

PRO JACKET

• GORE-TEX® product technology Guaranteed to Keep You Dry®
• Max vent with 2-way adjustable pit zips and back vent
• Asymmetric style uses 330D nylon shell and 3M® Scotchlite® reflective
• Durable 2-way YKK® Vision® zippers for adjustable and comfortable fit
• Drawcord adjustable neck, waist and Lycra® cuffs to keep snow out

2865003 | Red | S-3XL

2865002 | Black | S-3XL; MT-2XLT

PRO BIB

• GORE-TEX® product technology Guaranteed to Keep You Dry®
• 330D nylon shell with ballistic nylon reinforcement and 3M® Scotchlite® reflective
• Articulated knees with integrated EVA knee pads for added protection
• Durable, YKK® full-length 2-way adjustable water-resistant leg zippers
• External chest pocket and 2 side pockets

2865007 | Black | S-3XL; MT-2XLT



POLARIS®

ENGINEERED PARTS
ACCESSORIES & APPAREL

PROTECTION

TEKVEST®



TEKVEST® FREESTYLE
2862189 | S-3X



TEKVEST® SUPER SPORT
2862190 | S-3X



TEKVEST® SHOULDER PADS
2862192 | S-3X

YOUTH

YOUTH MX HELMET

2860174 | Black | S-M-L
2862171 | Red | S-M-L
2862172 | Blue | S-M-L



YOUTH RZ MASK

2863191 | Black | OSFM



YOUTH RZ MASK REPLACEMENT FILTERS (NOT SHOWN)

2863192 | OSFM | 3 per pack

POLARIS® YOUTH GOGGLES

2863435 | Black | OSFM



YOUTH SONIC™ GLOVES

2863406 | Black | S-M-L
2863407 | Red | M-L

YOUTH AERO GLOVES

2862187 | Black | S-M-L

YOUTH TEKVEST® (70-100 LB)

2862191 | Black



SEE PAGE 85 FOR SIZE CHARTS

When ordering, add size code to part number.
XS:01, S:02, M:03, M-Short:04, M-Tall:05,
L:06, L-Short:07, L-Tall:08, XL:09, XL-
Short:10, XL-Tall:11, 2XL:12, 2XL-Tall :13,
3XL:14, 4XL:15, 5XL:16

POLARIS®

ENGINEERED PARTS
ACCESSORIES & APPAREL

MEN'S CASUAL APPAREL



TELLICO HOODIE

100% polyester jersey fleece
2863533 | S-3XL



TELLICO HAT

100% cotton
2863540 | S/M
2864205 | L/XL



SAND MOUNTAIN HOODIE

80% cotton 20% polyester jersey fleece
2863532 | S-3XL



FLINT CREEK HOODIE

100% polyester top-dyed stripe jersey; wicking; AP-360°; UV
protection
2864226 | VooDoo/Midnight/White | S-3XL

MEN'S CASUAL APPAREL



IMPERIAL DUNES QUARTER ZIP

88% polyester 12% spandex jersey; wicking; AP-360°; UV protection

2864245 | Grey/Hi-Vis Yellow | S-3XL

2864246 | Charcoal Heather/Orange | S-3XL

2864247 | Black/VooDoo Blue | S-3XL



BORREGO RACER TEE

100% polyester with no-hole mesh inserts; wicking; AP-360°; UV protection

2864241 | Heather Gray | S-3XL

2864243 | Black | S-3XL



BLUFF CREEK TEE

100% polyester no hole mesh and insert mesh

2863529 | S-3XL



CARBON POLO

100% polyester carbon-fiber knit; wicking; AP-360°; UV protection; anti-static

2864232 | S-3XL



RIDGE RACER JERSEY

100% polyester no hole mesh and insert mesh

2863527 | Red | S-3XL

2863528 | Blue | S-3XL



SAND MOUNTAIN TEE

100% cotton jersey knit

2863531 | S-3XL



RZR®'S EDGE TEE

100% cotton jersey knit

2863530 | S-3XL

WOMEN'S CASUAL APPAREL



ALPINE LOOP ZIP
88% polyester 12% spandex with sublimated print; wicking; AP-360°; UV protection
2864266 | Black | S-2XL



CLOUD 9 HOODIE
100% cotton french terry
2863537 | S-3XL



MOUNTWOOD SLUB V-NECK
100% cotton yarn dyed slub jersey knit
2863536 | S-3XL



TAHUYA TEE
Cotton/polyester jersey burnout
2864264 | Black | S-2X



ALLEGHENY V TEE
100% cotton jersey
2864262 | Black | S-2X
2864261 | White | S-2X



SHILOH RIDGE CAP
100% cotton brushed twill
2864272 | OSFM



FREMONT CAP
100% cotton brushed twill
2864271 | OSFM

YOUTH CASUAL APPAREL



FLINT CREEK HOODIE
100% polyester top-dyed stripe jersey; wicking; AP-360°; UV protection
2864279 | Blue/White | S-XL



LA PAZ TRAIL RACER TEE
100% cotton heather overdyed jersey; biowashed
2864275 | Charcoal Heather | S-XL

SIZING CHARTS

MEN'S JACKET SIZNG

Size	Chest	Waist	Hips	Sleeve*	Inseam	Size Code
Small	35-38	31-33	35-37	33	32	02
Medium	38-41	33-35	37-40	34	32.5	03
Large	41-45	35-38	40-43	35	33	06
X-Large	45-48	38-42	43-47	36	33.5	09
2X-Large	48-52	42-45	47-50	37	34	12
3X-Large	52-58	45-52	50-56	38	34	14
4X-Large	58-65	52-61	56-63	39	35	15
5X-Large	65-70	61-63	63-68	40	35	16

WOMEN'S JACKET SIZING

Size	Chest	Waist	Hips	Sleeve*	Inseam	Size Code
Small	34-36	24-27	34-37	30	30.5	02
Medium	36-38	27-29	37-40	31	30.5	03
Large	38-40	29-33	40-43	32	31	06
X-Large	40-42	33-36	43-46	32.5	31	09
2X-Large	42-44	36-40	46-49	33	31	12

* Measure sleeve length from center back neck

YOUTH JACKET SIZING

Size	Height	Chest	Waist	Hips	Sleeve*	Inseam	Size Code
X-Small	41-46	22-24	19-21	23-26	22	21	01
Small	46-52	24-27	21-24	26-29	24	22.5	02
Medium	52-58	27-30	24-26	29-32	27	26.5	03
Large	58-64	30-33	26-28	32-35	30	29.5	06
X-Large	64-67	33-36	28-30	35-37	33	32.5	09

ADULT HELMET SIZE CONVERSIONS

Size	Hat Size	Inches	Metric	Size Code
X-Small	6.75	21.25	54	01
Small	6.875-7	21.625-22	55-56	02
Medium	7.125-7.25	22.375-22.75	57-58	03
Large	7-7.5	23.125-23.625	59-60	06
X-Large	7.625-7.75	24-24.375	61-62	09
2X-Large	7.875-8	24.75-25.125	63-64	12
3X-Large	8	25-26	65	14

YOUTH HELMET SIZE CONVERSIONS

Size	Circumference	Metric	Size Code
Adjustable	Fits S-L	51-54	00
Small	20.375	51	02
Medium	20.875	53	03
Large	21.375	55	06